

**FLUKE**®

**Hart Scientific**®

**7012**  
*Calibration Bath*  
*User Manual*

## **Limited Warranty & Limitation of Liability**

Each product from Fluke Corporation, Hart Scientific Division ("Hart") is warranted to be free from defects in material and workmanship under normal use and service. The warranty period is one year for the Calibration Bath. The warranty period begins on the date of the shipment. Parts, product repairs, and services are warranted for 90 days. The warranty extends only to the original buyer or end-user customer of a Hart authorized reseller, and does not apply to fuses, disposable batteries or to any other product, which in Hart's opinion, has been misused, altered, neglected, or damaged by accident or abnormal conditions of operation or handling. Hart warrants that software will operate substantially in accordance with its functional specifications for 90 days and that it has been properly recorded on non-defective media. Hart does not warrant that software will be error free or operate without interruption. Hart does not warrant calibrations on the Calibration Bath.

Hart authorized resellers shall extend this warranty on new and unused products to end-user customers only but have no authority to extend a greater or different warranty on behalf of Hart. Warranty support is available if product is purchased through a Hart authorized sales outlet or Buyer has paid the applicable international price. Hart reserves the right to invoice Buyer for importation costs of repairs/replacement parts when product purchased in one country is submitted for repair in another country.

Hart's warranty obligation is limited, at Hart's option, to refund of the purchase price, free of charge repair, or replacement of a defective product which is returned to a Hart authorized service center within the warranty period.

To obtain warranty service, contact your nearest Hart authorized service center or send the product, with a description of the difficulty, postage, and insurance prepaid (FOB Destination), to the nearest Hart authorized service center. Hart assumes no risk for damage in transit. Following warranty repair, the product will be returned to Buyer, transportation prepaid (FOB Destination). If Hart determines that the failure was caused by misuse, alteration, accident or abnormal condition or operation or handling, Hart will provide an estimate or repair costs and obtain authorization before commencing the work. Following repair, the product will be returned to the Buyer transportation prepaid and the Buyer will be billed for the repair and return transportation charges (FOB Shipping Point).

THIS WARRANTY IS BUYER'S SOLE AND EXCLUSIVE REMEDY AND IS IN LIEU OF ALL OTHER WARRANTIES, EXPRESS OR IMPLIED, INCLUDING BUT NOT LIMITED TO ANY IMPLIED WARRANTY OF MERCHANTABILITY OR FITNESS FOR A PARTICULAR PURPOSE. HART SHALL NOT BE LIABLE FOR ANY SPECIAL, INDIRECT, INCIDENTAL, OR CONSEQUENTIAL DAMAGES OR LOSSES, INCLUDING LOSS OF DATA, WHETHER ARISING FROM BREACH OF WARRANTY OR BASED ON CONTRACT, TORT, RELIANCE OR ANY OTHER THEORY.

Since some countries or states do not allow limitation of the term of an implied warranty, or exclusion or limitation of incidental or consequential damages, the limitations and exclusions of this warranty may not apply to every buyer. If any provision of this Warranty is held invalid or unenforceable by a court of competent jurisdiction, such holding will not affect the validity or enforceability of any other provision.

### **Fluke Corporation, Hart Scientific Division**

799 E. Utah Valley Drive • American Fork, UT 84003-9775 • USA  
Phone: +1.801.763.1600 • Telefax: +1.801.763.1010  
E-mail: support@hartscientific.com

**www.hartscientific.com**

Subject to change without notice. • Copyright © 2006 • Printed in USA

# Table of Contents

<b>1</b>	<b>Before You Start</b>	<b>1</b>
1.1	Symbols Used	1
1.2	Safety Information	2
1.2.1	WARNINGS	2
1.2.2	CAUTIONS	4
1.3	Authorized Service Centers	5
<b>2</b>	<b>Introduction</b>	<b>9</b>
<b>3</b>	<b>Specifications and Environmental Conditions</b>	<b>11</b>
3.1	Specifications	11
3.2	Environmental Conditions	12
<b>4</b>	<b>Quick Start</b>	<b>13</b>
4.1	Unpacking	13
4.2	Set Up	13
4.3	Power	14
4.4	Setting the Temperature	14
<b>5</b>	<b>Installation</b>	<b>17</b>
5.1	Bath Environment	17
5.2	“Dry-out” Period	17
5.3	Bath Preparation and Filling	17
5.4	Probe	18
5.5	Power	18
<b>6</b>	<b>Bath Use</b>	<b>19</b>
6.1	General	19
6.2	Comparison Calibration	19
6.3	Calibration of Multiple Probes	20
<b>7</b>	<b>Parts and Controls</b>	<b>21</b>
7.1	Front Control Panel	21
7.2	Side Panel	22
7.3	Back Panel	23
7.4	Bath Tank and Lid	24

<b>8</b>	<b>General Operation . . . . .</b>	<b>27</b>
8.1	Heat Transfer Fluid . . . . .	27
8.1.1	Temperature Range . . . . .	27
8.1.2	Viscosity . . . . .	27
8.1.3	Specific Heat . . . . .	28
8.1.4	Thermal Conductivity . . . . .	28
8.1.5	Thermal Expansion . . . . .	28
8.1.6	Electrical Resistivity . . . . .	28
8.1.7	Fluid Lifetime . . . . .	28
8.1.8	Safety . . . . .	28
8.1.9	Cost . . . . .	29
8.1.10	Commonly Used Fluids . . . . .	29
8.1.10.1	Water . . . . .	29
8.1.10.2	Ethylene Glycol . . . . .	29
8.1.10.3	Methanol . . . . .	29
8.1.10.4	Mineral Oil . . . . .	30
8.1.10.5	Silicone Oils . . . . .	30
8.1.11	Fluid Characteristics Charts . . . . .	30
8.1.11.1	Limitations and Disclaimer . . . . .	30
8.1.11.2	About the Graph . . . . .	31
8.2	Stirring . . . . .	33
8.3	Power . . . . .	33
8.4	Heater . . . . .	33
8.5	Cooling . . . . .	34
8.6	Fluid Drain . . . . .	34
8.7	Temperature Controller . . . . .	34
<b>9</b>	<b>Controller Operation . . . . .</b>	<b>37</b>
9.1	Bath Temperature . . . . .	37
9.2	Reset Cutout . . . . .	37
9.3	Temperature Set-point . . . . .	39
9.3.1	Programmable Set-points . . . . .	39
9.3.2	Set-point Value . . . . .	40
9.3.3	Set-point Vernier . . . . .	40
9.4	Temperature Scale Units . . . . .	41
9.5	Secondary Menu . . . . .	42
9.6	Heater Power . . . . .	42
9.7	Proportional Band . . . . .	42
9.8	Cutout . . . . .	44
9.9	Controller Configuration . . . . .	45
9.10	Probe Parameters . . . . .	46
9.10.1	D0 . . . . .	46
9.10.2	Dg . . . . .	46
9.11	Operating Parameters . . . . .	46
9.11.1	Cutout Reset Mode . . . . .	46

9.12	Serial Interface Parameters . . . . .	47
9.12.1	Baud Rate . . . . .	47
9.12.2	Sample Period. . . . .	48
9.12.3	Duplex Mode . . . . .	48
9.12.4	Linefeed. . . . .	48
9.13	IEEE-488 Parameters . . . . .	49
9.13.1	IEEE-488 Address . . . . .	49
9.14	Calibration Parameters . . . . .	49
9.14.1	CTO . . . . .	50
9.14.2	H and L . . . . .	50
<b>10</b>	<b>Digital Communication Interface . . . . .</b>	<b>51</b>
10.1	Serial Communications . . . . .	51
10.1.1	Wiring. . . . .	51
10.1.2	Setup . . . . .	51
10.1.2.1	Baud rate . . . . .	52
10.1.2.2	Sample Period. . . . .	52
10.1.2.3	Duplex Mode . . . . .	52
10.1.2.4	Linefeed. . . . .	52
10.1.3	Serial Operation. . . . .	53
10.2	IEEE-488 Communication . . . . .	53
10.2.1	Setup . . . . .	53
10.2.1.1	IEEE-488 Interface Address . . . . .	53
10.2.2	IEEE-488 Operation . . . . .	53
10.3	Interface Commands . . . . .	53
10.4	Power Control Functions . . . . .	56
10.4.1	Heater Control . . . . .	56
10.4.2	Cooling Control. . . . .	56
<b>11</b>	<b>Calibration Procedure . . . . .</b>	<b>59</b>
11.1	Calibration Points . . . . .	59
11.2	Measuring the Set-point Error. . . . .	59
11.3	Computing D0 and DG . . . . .	60
11.4	Calibration Example. . . . .	60
<b>12</b>	<b>Maintenance . . . . .</b>	<b>63</b>
12.1	Draining the Bath . . . . .	64
<b>13</b>	<b>Troubleshooting. . . . .</b>	<b>67</b>
13.1	Troubleshooting . . . . .	67
13.2	Comments . . . . .	70
13.2.1	EMC Directive . . . . .	70
13.2.2	Low Voltage Directive (Safety). . . . .	70

# Figures and Tables













Figure 1	Bath Assembly . . . . .	9
Figure 2	Front Panel . . . . .	21
Figure 3	Refrigeration Controls - Side Panel . . . . .	22
Figure 4	Back Panel . . . . .	24
Figure 5	Drain Location and Lid Options . . . . .	25
Figure 6	Chart of various bath fluids and their properties . . . . .	31
Table 2	Table of various bath fluids and their properties . . . . .	32
Figure 7	Controller Operation Flowchart . . . . .	38
Table 3	Proportional Band — Fluid Table . . . . .	43
Figure 8	Bath temperature fluctuation at various proportional band settings . . . .	43
Figure 9	Serial Communications Cable Wiring . . . . .	51
Table 4	Interface Command Summary . . . . .	54
Table 4	Digital Communications Commands continued . . . . .	55
Table 5	Serial Power Control Functions . . . . .	57
Table 6	Temperature Range Control Functions . . . . .	57
Figure 10	Sample calibration computations . . . . .	61



# 1 Before You Start

## 1.1 Symbols Used

Table 1 lists the International Electrical Symbols. Some or all of these symbols may be used on the instrument or in this manual.

**Table 1** International Electrical Symbols

Symbol	Description
	AC (Alternating Current)
	AC-DC
	Battery
	CE Complies with European Union Directives
	DC
	Double Insulated
	Electric Shock
	Fuse
	PE Ground
	Hot Surface (Burn Hazard)
	Read the User's Manual (Important Information)
	Off
	On

Symbol	Description
	Canadian Standards Association
<b>CAT II</b>	OVERVOLTAGE (Installation) CATEGORY II, Pollution Degree 2 per IEC1010-1 refers to the level of Impulse Withstand Voltage protection provided. Equipment of OVERVOLTAGE CATEGORY II is energy-consuming equipment to be supplied from the fixed installation. Examples include household, office, and laboratory appliances.
	C-TIC Australian EMC Mark
	The European Waste Electrical and Electronic Equipment (WEEE) Directive (2002/96/EC) mark.

## 1.2 Safety Information

Use this instrument only as specified in this manual. Otherwise, the protection provided by the instrument may be impaired.

The following definitions apply to the terms “Warning” and “Caution”.

- “WARNING” identifies conditions and actions that may pose hazards to the user.
- “CAUTION” identifies conditions and actions that may damage the instrument being used.

### 1.2.1 WARNINGS

To avoid possible electric shock or personal injury, follow these guidelines.

#### GENERAL

- **DO NOT** use the instrument for any application other than calibration work. The instrument was designed for temperature calibration. Any other use of the unit may cause unknown hazards to the user.
- **DO NOT** use the unit in environments other than those listed in the user’s guide.
- **DO NOT** overfill the bath. Overflowing extremely cold or hot fluid may be harmful to the operator. See Section 5.3, Bath Preparation and Filling, for specific instructions.
- Follow all safety guidelines listed in the user’s manual.
- Calibration Equipment should only be used by Trained Personnel.
- If this equipment is used in a manner not specified by the manufacturer, the protection provided by the equipment may be impaired.
- Before initial use, or after transport, or after storage in humid or semi-humid environments, or anytime the instrument has not been energized for more than 10 days, the instrument needs to be energized for a "dry-out"



period of 2 hours before it can be assumed to meet all of the safety requirements of the IEC 1010-1. If the product is wet or has been in a wet environment, take necessary measures to remove moisture prior to applying power such as storage in a low humidity temperature chamber operating at 50 degree centigrade for 4 hours or more.

- **DO NOT** operate high temperature baths (500°C) near flammable materials. Extreme temperatures could ignite the flammable material.
- Overhead clearance is required. Do not place the instrument under a cabinet or other structure. Always leave enough clearance to allow for safe and easy insertion and removal of probes.
- The instrument is intended for indoor use only.

### **BURN HAZARD**

- Extremely cold temperatures may be present in this equipment. Freezer burns and frostbite may result if personnel fail to observe safety precautions.
- High temperatures may be present in this equipment. Fires and severe burns may result if personnel fail to observe safety precautions.

### **ELECTRICAL HAZARD**

- These guidelines must be followed to ensure that the safety mechanisms in this instrument will operate properly. This mains supply for the instrument must be capable of supplying power to the instrument as listed in Section 3.1, Specifications. The power cord of the instrument is equipped with a three-pronged grounding plug for your protection against electrical shock hazards. It must be plugged directly into a properly grounded three-prong receptacle. The receptacle must be installed in accordance with local codes and ordinances. Consult a qualified electrician. **DO NOT** use an extension cord or adapter plug.
- **DO** use a ground fault interrupt device. This unit contains a liquid. A ground fault device is advised in case liquid is present in the electrical system and could cause an electrical shock.
- Always replace the power cord with an approved cord of the correct rating and type. If you have questions, contact an Authorized Service Center (see Section 1.3).
- High voltage is used in the operation of this equipment. Severe injury or death may result if personnel fail to observe the safety precautions. Before working inside the equipment, turn off the power and disconnect the power cord.

### **BATH FLUIDS**

- Fluids used in this unit may produce noxious or toxic fumes under certain circumstances. Consult the fluid manufacturer's MSDS (Material Safety Data Sheet). Proper ventilation and safety precautions must be observed.

- The instrument is equipped with a soft cutout (user settable firmware) and a hard cutout (set at the factory). Check the flash point, boiling point, or other fluid characteristic applicable to the circumstances of the unit operation. Ensure that the soft cutout is adjusted to the fluid characteristics of the application. As a guideline, the soft cutout should be set 10°C to 15°C below the flash point of the bath fluid. See Section 8.1, Heat Transfer Fluid, for specific information on bath fluids and Section 9.8, Cutout.

## 1.2.2 CAUTIONS

To avoid possible damage to the instrument, follow these guidelines.

- Always operate the instrument in room temperatures listed in Section 3.2, Environmental Conditions. Allow sufficient air circulation by leaving at least 15 cm (6 inches) of clearance around the instrument.
- **DO NOT** overfill the bath. Overflowing liquid may damage the electrical system. Be sure to allow for thermal expansion of the fluid as the bath temperature increases. See Section 5.3, Bath Preparation and Filling, for specific instructions.
- Read Section 6, Bath Use, before placing the unit into service.
- **DO NOT** change the values of the bath calibration constants from the factory set values. The correct setting of these parameters is important to the safety and proper operation of the unit.
- The refrigeration may be damaged or the lifetime shortened if the set-point temperature is set above 60°C for more than one hour with the refrigeration manually on. Ensure that the refrigeration is off when the unit is used above 60°C.
- The **Factory Reset Sequence** should be performed only by authorized personnel if no other action is successful in correcting a malfunction. You must have a copy of the most recent Report of Test to restore the test parameters.
- **DO NOT** operate this instrument in an excessively wet, oily, dusty, or dirty environment.
- The unit is a precision instrument. Although it has been designed for optimum durability and trouble free operation, it must be handled with care. Position the unit before the tank is filled with fluid. Use the handles provided to move the unit. Due to the weight of the compressor, it may require two people to safely move the bath. If two people are used, place one person in the front and one person in the back of the unit, carefully slide hands under the unit and lift in unison. The area containing the compressor will be heavier than the rest of the unit. **Do not move a unit filled with fluid.**
- Most probes have handle temperature limits. Be sure that the probe handle temperature limit is not exceeded in the air above the instrument.

- The instrument and any thermometer probes used with it are sensitive instruments that can be easily damaged. Always handle these devices with care. Do not allow them to be dropped, struck, stressed, or overheated.

### COLD BATHS

- Refrigerated baths require that the condensing coil be cleaned periodically. Accumulation of dust and dirt on the condenser will result in premature failure of the compressor.
- This bath has been equipped with a brownout and over voltage protection device as a safety feature to protect the system components.
- **Mode of Operation:** This bath needs to be plugged into the line voltage for at least two minutes before operation. This is only necessary for the first time that the bath is energized or when it is moved from one location to another. Turning the bath ON or OFF does not trigger the delay.
- If a **High/Low voltage condition** exists for longer than 5 seconds, the bath will be de-energized. The “Mains Out of Range” light on the back of the bath will be lit indicating a fault condition. Re-energization is automatic upon correction of the fault condition and after a delay cycle of about two minutes. If a fault condition exists upon application of power, the bath will not energize.

Under and Over Voltage Protection at 115 VAC  
Voltage Cutout:  $\pm 12.5\%$  (101 - 129 VAC)  
Voltage Cut In:  $\pm 7.5\%$  (106 - 124 VAC)

Under and Over Voltage Protection at 230 VAC  
Voltage Cutout:  $\pm 12.5\%$  (203 - 257 VAC)  
Voltage Cut In:  $\pm 7.5\%$  (213 - 247 VAC)

## 1.3 Authorized Service Centers

Please contact one of the following authorized Service Centers to coordinate service on your Hart product:

### **Fluke Corporation, Hart Scientific Division**

799 E. Utah Valley Drive  
American Fork, UT 84003-9775  
USA

Phone: +1.801.763.1600  
Telefax: +1.801.763.1010  
E-mail: [support@hartscientific.com](mailto:support@hartscientific.com)

**Fluke Nederland B.V.**

Customer Support Services  
Science Park Eindhoven 5108  
5692 EC Son  
NETHERLANDS

Phone: +31-402-675300  
Telefax: +31-402-675321  
E-mail: ServiceDesk@fluke.nl

**Fluke Int'l Corporation**

Service Center - Instrimpex  
Room 2301 Sciteck Tower  
22 Jianguomenwai Dajie  
Chao Yang District  
Beijing 100004, PRC  
CHINA

Phone: +86-10-6-512-3436  
Telefax: +86-10-6-512-3437  
E-mail: xingye.han@fluke.com.cn

**Fluke South East Asia Pte Ltd.**

Fluke ASEAN Regional Office  
Service Center  
60 Alexandra Terrace #03-16  
The Comtech (Lobby D)  
118502  
SINGAPORE

Phone: +65 6799-5588  
Telefax: +65 6799-5588  
E-mail: antng@singa.fluke.com

When contacting these Service Centers for support, please have the following information available:

- Model Number
- Serial Number

- Voltage
- Complete description of the problem

## 2 Introduction

The Hart Scientific 7012 bath is a very precise constant temperature bath. An innovative state of the art solid-state temperature controller has been incorporated which maintains the bath temperature with extreme stability. The controller uses a microcontroller to execute the many operating functions.

User interface is provided by the 8-digit LED display and four key-switches. Digital remote communications is optionally available with a RS-232 or IEEE-488 interface.

The tank for the 7012 is stainless steel and holds 36 liters. There are two lids available; the standard lid with a rectangular access hole and an optional lid with a recirculating pump (see Figure 5).

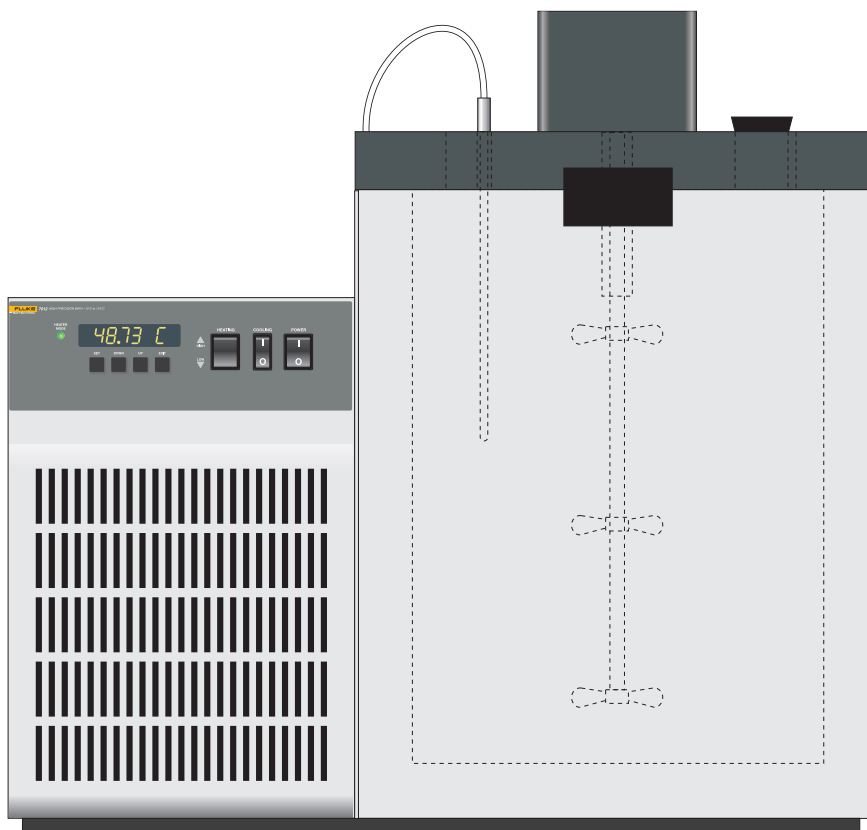

**Figure 1** Bath Assembly

# 3 Specifications and Environmental Conditions

## 3.1 Specifications

Range	-10°C to 110°C (14°F to 230°F)
Stability	±0.0008°C at 0°C (ethanol) ±0.0008°C at 25°C (water) ±0.003°C at 100°C (oil 5012)
Uniformity	±0.003°C at 0°C (ethanol) ±0.002°C at 25°C (water) ±0.004°C at 100°C (oil 5012)
Temperature Setting	Digital display with push-button data entry
Set-point Resolution	0.002°C; high-resolution mode, 0.00003°C
Display Resolution	0.01°C
Digital Setting Accuracy	±1°C
Digital Setting Repeatability	±0.005°C
Heaters	500 and 1000 Watts
Safety Cutout	Factory-set high temperature
Temperature Drift per ±°C Ambient or ±10 VAC line	±0.2m°C
Pump Recirculation (optional)	15 L/min
Access Opening	162 mm X 292 mm (6.38" X 11.5")
Depth	457 mm (18")
Wetted Parts	304 stainless steel
Volume	42 liters (11.2 gallons)
Weight	68 kg (150 lb.)
Size	762 mm H X 686 mm W X 401 mm D (30" X 27" X 15.8")
Power	115 VAC (±10%), 60 Hz, 1570 W 230 VAC (±10%), 60 Hz, 1570 W (50 Hz Optional)  <b>NOTE:</b> If voltage is outside ±10% VAC, the compressor may be damaged. Check the back panel label for the correct voltage and frequency prior to energizing the instrument.
System Fuse	115 VAC: 15 A 250 V slow blow 230 VAC: 8 A 250 V slow blow

<b>Heater Fuse</b>	115 VAC: 10 A 250 V fast blow 230 VAC: 6 A 250 V fast blow
<b>Safety</b>	OVERVOLTAGE (Installation) CATEGORY II, Pollution Degree 2 per IEC 61010-1

## 3.2 Environmental Conditions

Although the instrument has been designed for optimum durability and trouble-free operation, it must be handled with care. The instrument should not be operated in an excessively dusty or dirty environment. Maintenance and cleaning recommendations can be found in the Maintenance Section of this manual.

The instrument operates safely under the following conditions:

- ambient temperature range: 5–50°C (41–122°F)
- ambient relative humidity: maximum 80% for temperature <31°C, decreasing linearly to 50% at 40°C
- pressure: 75kPa–106kPa
- mains voltage within  $\pm 10\%$  of nominal
- vibrations in the calibration environment should be minimized
- altitude does not effect the performance or safety of the unit
- indoor use only



## 4 Quick Start



**CAUTION:** READ SECTION 6 ENTITLED “BATH USE” before placing the bath in service. Incorrect handling can damage the bath and void the warranty.

This section gives a brief summary of the steps required to set up and operate the 7012 bath. This should be used as a general overview and reference and not as a substitute for the remainder of the manual. Please read Section 5 through 7 carefully before operating the bath.

### 4.1 Unpacking

Unpack the bath carefully and inspect it for any damage that may have occurred during shipment. If there is shipping damage, notify the carrier immediately.

Verify that all components are present:

- 7012 Bath
- Controller Probe
- Access Hole Cover
- User’s Guide
- Report of TEst
- Fill Hole Cover
- Drain Elbow

If you are missing any item, please contact an Authorized Service Center.

### 4.2 Set Up

Set up of the bath requires careful unpacking and placement of the bath, filling the bath with fluid, installing the probe and connecting power. Consult Section 5 for detailed instructions for proper installation of the bath. Be sure to place the bath in a safe, clean and level location.

Fill the bath tank with an appropriate liquid. For operation at moderate bath temperatures, clean distilled water works well. Carefully pour the fluid into the bath tank through the large rectangular access hole above the tank avoiding spilling any fluid. The fluid must not exceed a height of 1/2 inch below the bath lid.

The control probe must be inserted through the lid into the bath and plugged into the socket at the back of the bath.

### 4.3 Power

Plug the bath power cord into a mains outlet of the proper voltage, frequency, and current capability. Refer to Section 3.1, Specifications, for power requirement details. Refer to and read the WARNING at the front of this manual concerning brownout and over voltage protection.

Set the "HEATER" switch on the front panel to position "LOW" and turn the bath on using the front panel "POWER" switch. The bath will turn on and begin to heat or cool to reach the previously programmed temperature set-point. The front panel LED display will indicate the actual bath temperature.

### 4.4 Setting the Temperature

In the following discussion a solid box around the word SET, UP, EXIT or DOWN indicates the panel button while the dotted box indicates the display reading. Explanation of the button or display reading are to the right of each button or display value.

To view or set the bath temperature set-point proceed as follows. The front panel LED display normally shows the actual bath temperature.

 Bath temperature display

When "SET" is pressed the display shows the set-point memory that is currently being used and its value. Eight set-point memories are available.

 Access set-point selection

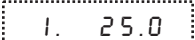
 Set-point 1, 25.0°C currently used

Press "SET" to select this memory and access the set-point value.

 Access set-point value

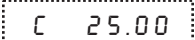
 Current value of set-point 1, 25.00°C

Press "UP" or "DOWN" to change the set-point value.

 Increment display

 New set-point value

Press "SET" to accept the new value and display the vernier value. The bath begins heating or cooling to the new set-point.



*Store new set-point, access vernier*



*Current vernier value*

Press "EXIT" and the bath temperature is displayed again.



*Return to the temperature display*

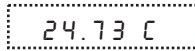

*Bath temperature display*

The bath heats or cools until it reaches the new set-point temperature. Set the heater switch to position "HIGH" to allow the bath to more quickly reach a higher temperature. The "HIGH" setting may be necessary to reach higher temperatures and control at high temperatures.

When setting the set-point temperature be careful not to exceed the temperature limit of the bath fluid. The over-temperature cut-out should be correctly set to prevent this from happening. See Section 9.8.

If operating the bath below 45 °C set the COOLING power switch to ON. The cooling temperature may require adjustment to provide the proper amount of cooling. See Section 8.5.

To obtain optimum control stability adjust the proportional band as discussed in Section 9.7.

## 5 Installation



**CAUTION:** READ SECTION 6 ENTITLED “BATH USE ”before placing the bath in service. Incorrect handling can damage the bath and void the warranty.

This bath is not designed to be portable. Therefore, moving the bath once it has been installed should be kept to a minimum.



**CAUTION:** Never move a bath that is full of fluid. This action could be extremely dangerous and could result in personal injury to the person moving the bath.

If the bath is going to be placed in an area where it will need to be moved frequently, a special cart can be designed to accommodate the bath making the bath much more portable. Hart sells carts designed for these baths. However, even with a cart the bath should not be moved full of fluid. The fluid can splash causing injury or if the bath and cart tip, the fluid could cause damage to the surrounding area and personal injury to personnel.

If the bath must be moved, be sure to drain the fluid to prevent any injury. The side of the bath with the compressor is heavier than the tank side. To safely move the bath, two people are required.

### 5.1 Bath Environment

The Model 7012 Bath is a precision instrument which should be located in an appropriate environment. The location should be free of drafts, extreme temperatures and temperature changes, dirt, etc. The surface where the bath is placed must be level.

If used at higher temperatures where fluid vaporization is significant, a fume hood should be used.

### 5.2 “Dry-out” Period

Before initial use, after transport, and any time the instrument has not been energized for more than 10 days, the bath will need to be energized for a “dry-out” period of 1-2 hours before it can be assumed to meet all of the safety requirements of the IEC 1010-1.

### 5.3 Bath Preparation and Filling

The 7012 Bath is not provided with a fluid. Various fluids are available from Hart Scientific and other sources. Depending on the desired temperature range, any of the following fluids, as well as others, may be used in the bath:

- Water
- Ethylene Glycol/Water
- Methanol
- Mineral oil
- Silicone oil

Fluids are discussed in detail in Section 8.1.

Remove any access hole cover from the bath and check the tank for foreign matter (dirt, remnant packing material, etc.). Use clean unpolluted fluid. Carefully fill the bath through the large square access hole to a level that will allow for stirring and thermal expansion. The fluid should never exceed a height of 1/2" below the top of the tank. Carefully monitor the bath fluid level as the bath temperature rises to prevent overflow or splashing. Remove excess fluid if necessary and with caution if the fluid is hot.

Be careful to prevent bath fluid from spilling on the stirring motor while filling.



**CAUTION:** Under filling may reduce bath performance and may possibly damage the bath heater.

## 5.4 Probe

Inspect the bath controller probe. This probe should not be bent or damaged in any way. Reasonable caution should be used in handling this probe as it contains a precision thermistor sensor. If damaged, the probe can be replaced. Contact an Authorized Service Center for assistance.

Insert the probe into the 1/4 inch probe hole at the top left side of the bath lid. The tip of the probe must be well immersed in the fluid. The probe connector is plugged into the rear of the bath into the socket labeled "PROBE".

## 5.5 Power

With the bath power switch off, plug the bath into an AC mains outlet of the appropriate voltage, frequency, and current capacity. Refer to Section 3.1, Specifications, for power requirement details. Refer to and read the WARNING at the front of this manual concerning brownout and over voltage protection.

Be sure the stirring motor power cord is plugged into the "STIRRER" socket at the back of the bath.

## 6 Bath Use

### READ BEFORE PLACING THE BATH IN SERVICE

The information in this section is for general information only. It is not designed to be the basis for calibration laboratory procedures. Each laboratory will need to write their own specific procedures.

### 6.1 General

Be sure to select the correct fluid for the temperature range of the calibration. Bath fluids should be selected to operate safely with adequate thermal properties to meet the application requirements. Also, be aware that some fluids expand and could overflow the bath if not watched. Refer to General Operation, section 8, for information specific to fluid selection and to the MSDS sheet specific to the fluid selected. Generally, baths are set to one temperature and used to calibrate probes only at that single temperature. This means that the type of bath fluid does not have to change. Additionally, the bath can be left energized reducing the stress on the system.

The bath generates extreme temperatures. Precautions must be taken to prevent personal injury or damage to objects. Probes may be extremely hot or cold when removed from the bath. Cautiously handle probes to prevent personal injury. Carefully place probes on a heat/cold resistant surface or rack until they are at room temperature. It is advisable to wipe the probe with a clean soft cloth or paper towel before inserting it into another bath. This prevents the mixing of fluids from one bath to another. If the probe has been calibrated in liquid salt, carefully wash the probe in warm water and dry completely before transferring it to another fluid. Always be sure that the probe is completely dry before inserting it into a hot fluid. Some of the high temperature fluids react violently to water or other liquid mediums. Be aware that cleaning the probe can be dangerous if the probe has not cooled to room temperature. Additionally, high temperature fluids may ignite the paper towels if the probe has not been cooled.

For optimum accuracy and stability, allow the bath adequate stabilization time after reaching the set-point temperature.

### 6.2 Comparison Calibration

Comparison calibration involves testing a probe (unit under test, UUT) against a reference probe. After inserting the probes to be calibrated into the bath, allow sufficient time for the probes to settle and the temperature of the bath to stabilize.

One of the significant dividends of using a bath rather than a dry-well to calibrate multiple probes is that the probes do not need to be identical in construction. The fluid in the bath allows different types of probes to be calibrated at the same time. However, stem effect from different types of probes is not totally eliminated. Even though all baths have horizontal and vertical gradients,

these gradients are minimized inside the bath work area. Nevertheless, probes should be inserted to the same depth in the bath liquid. Be sure that all probes are inserted deep enough to prevent stem effect. From research at Hart Scientific, we suggest a general rule-of-thumb for immersion depth to reduce the stem effect to a minimum: 15 x the diameter of the UUT + the sensor length.

**Do not submerge the probe handles.** If the probe handles get too warm during calibration at high temperatures, a heat shield could be used just below the probe handle. This heat shield could be as simple as aluminum foil slid over the probe before inserting it in the bath or as complicated as a specially designed reflective metal apparatus.

When calibrating over a wide temperature range, better results can generally be achieved by starting at the highest temperature and progressing down to the lowest temperature.

Probes can be held in place in the bath by using probe clamps or drilling holes in the access cover. Other fixtures to hold the probes can be designed. The object is to keep the reference probe and the probe(s) to be calibrated as closely grouped as possible in the working area of the bath. Bath stability is maximized when the bath working area is kept covered.

In preparing to use the bath for calibration start by:

- Placing the reference probe in the bath working area.
- Placing the probe to be calibrated, the UUT, in the bath working area as close as feasibly possible to the reference probe.

### **6.3 Calibration of Multiple Probes**

Fully loading the bath with probes increases the time required for the temperature to stabilize after inserting the probes. Using the reference probe as the guide, be sure that the temperature has stabilized before starting the calibration.

## 7 Parts and Controls

### 7.1 Front Control Panel

The following controls and indicators are present on the controller front panel (see Figure 2 below): (1) the digital LED display, (2) the control buttons, (3) the bath on/off power switch, (4) the control indicator light, (5) the heater power switch, and (6) the cooling power switch.

(1) The digital display is an important part of the temperature controller because it not only displays set and actual temperatures but also displays various bath functions, settings, and constants. The display shows temperatures in values according to the selected scale units °C or °F.

(2) The control buttons (SET, DOWN, UP, and EXIT) are used to set the bath temperature set-point, access and set other operating parameters, and access and set bath calibration parameters.

A brief description of the functions of the buttons follows:

**SET** – Used to display the next parameter in a menu and to set parameters to the displayed value.

**DOWN** – Used to decrement the displayed value of settable parameters.

**UP** – Used to increment the displayed value.

**EXIT** – Used to exit from a menu. When “EXIT” is pressed any changes made to the displayed value are ignored.

(3) The on/off switch controls power to the entire bath assembly. It powers the stirring motor and the bath controller/heater circuit.

(4) The control indicator is a two color light emitting diode. This indicator lets the user visually see the ratio of heating to cooling. When the indicator is red,



Figure 2 Front Panel



the heater is ON. When the indicator is green the heater is OFF and the bath is cooling.

(5) The heater power switch is used to select the appropriate heater power levels for heating and controlling the bath at various temperatures.

(6) The cooling power switch controls power to the cooling compressor and cooling fan.

## 7.2 Side Panel

The side panel has three features (see Figure 3): 1) the back pressure valve, 2) the cooling temperature regulating valve, and 3) the cooling temp gauge. With the interface option an extra cooling valve (HIGH) is provided.

- 1) The back pressure valve adjustment is used to control the amount of cooling supplied to the system. This valve reduces the cooling capacity by restricting the flow of refrigerant to the bath, allowing the adjustment of the heating to cooling percentage. Under normal operation the valve should be fully open (counter clockwise).

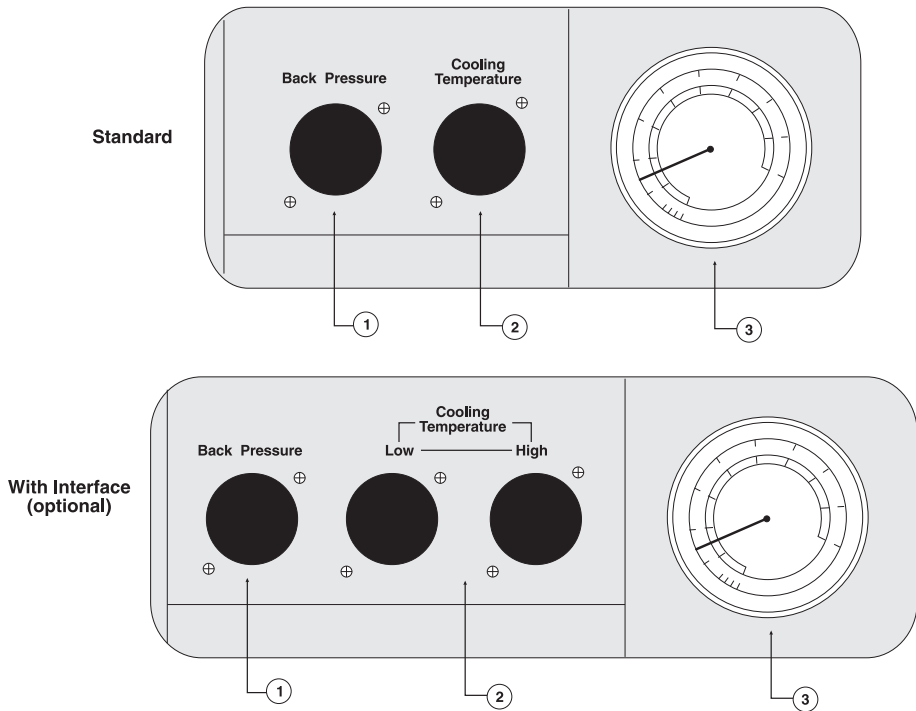

**Figure 3** Refrigeration Controls - Side Panel

- 2) The cooling temperature regulating valve is used to adjust the temperature at which the refrigerant evaporates, which determines cooling efficiency. Refer to the label below the gauge for approximate psi and evaporative temperature settings. The following table is reproduced from the label.

For this bath: Control Temperature		Set the Cooling Temp. Valve to this pressure
°C	°F	Nominal Cooling PSIG
-10	14	4.7
-5	23	9.2
0	32	14.5
5	41	20.7
10	50	27.9
15	59	36.1
20	68	45.5
25	77	56.2
30	86	68.4
35	95	82.1
37	98.6	86

**DO NOT set the Cooling Pressure above 90 PSIG**

- 3) The cooling temp gauge is used to indicate the temperature at which the refrigerant is evaporating. The cooling temp regulating valve is used to set and then control this temperature.

## 7.3 Back Panel

The back panel has five standard features and two optional features (see [Figure 4](#)): 1) the probe connector, 2) the stirrer power outlet, 3) the power cord, 4) the drain valve, 5) serial number notation, 6) the RS-232 interface connector (optional), and 7) the IEEE-488 interface connector (optional). The system fuses are internal.

- 1) The probe connector on the back panel is used for the temperature controller probe.
- 2) The stirrer power is provided for the stirring motor.
- 3) The power cord.
- 4) A drain valve is provided for ease of removing the fluid media from the bath. Always use a container of adequate size to hold the **FULL LOAD** of fluid. Some oils are more easily drained at higher temperatures. (See caution note in next section.)

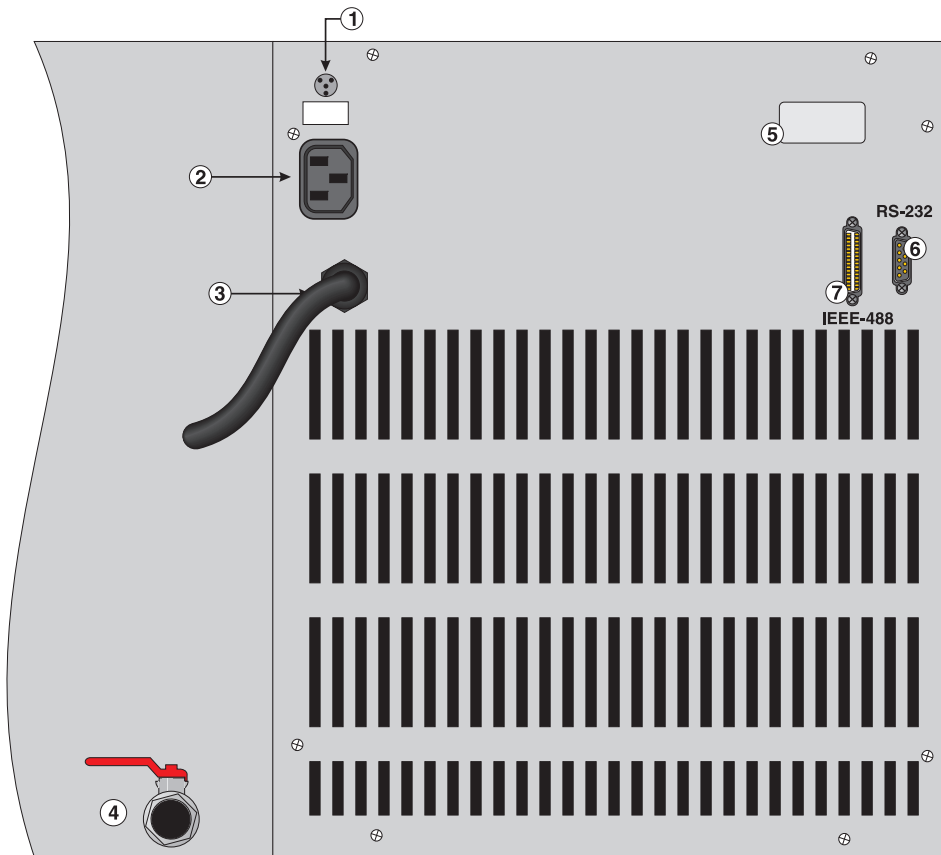

**Figure 4** Back Panel

- 5) The serial number is located on the upper right corner of the back panel. When contacting an Authorized Service Center, use the serial number and model number.
- 6) If the bath is supplied with a serial RS-232 interface, the interface cable attaches to the back of the bath at the connector labeled “RS-232”.
- 7) If the bath is supplied with a GPIB IEEE-488 interface, the interface cable attaches to the back of the bath at the connector labeled “IEEE-488”.

## 7.4 Bath Tank and Lid

There are two different types of lids. They both have the same overall dimensions but the optional lid (see Figure 5) has a recirculating pump and the standard lid has a stirring motor with rectangular access hole. Their features are described with reference to figure numbers as follows:

- 1) The top half of the latch attaches the lid to the bath. There are two latches; one on the front and one on the back.
- 2) The thermometer/liquid level is a hole in the lid for filling and removing of liquid, checking liquid level, and for mounting a thermometer. A hole may be drilled in the rubber stopper supplied for inserting a thermometer into the bath.
- 3) The rectangular access hole, on the standard lid, may be used to insert the users device to be thermostatted. To obtain specified control levels this hole must be covered to prevent thermal disturbance to the bath. Covers may be purchased separately from Hart Scientific.
- 3) The circulation inlet - outlet on the pump lid is the access area or the inlet and outlet for the circulation pump.

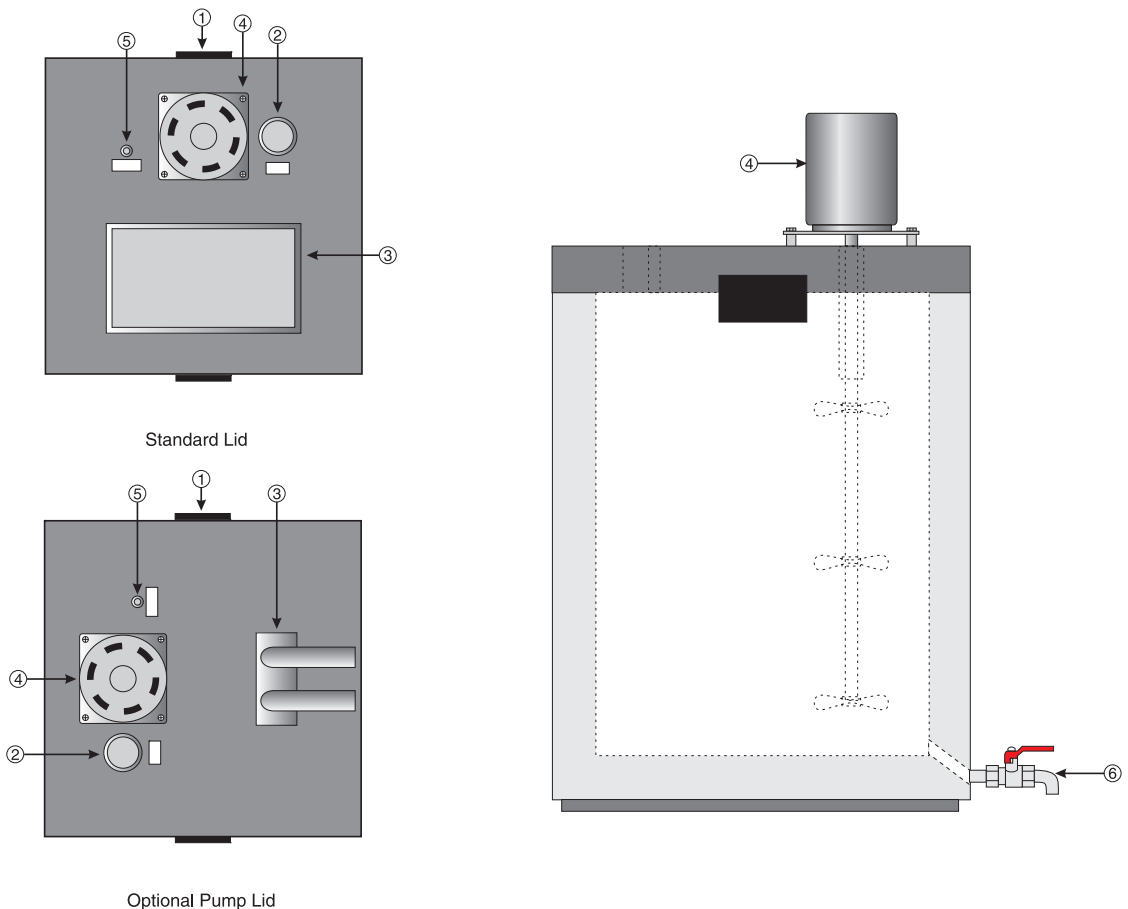

**Figure 5** *Drain Location and Lid Options*

- 4) The stirrer/pump motor drives the stirring propellers to provide mixing of the bath fluid. Proper mixing of the fluid is important for good constant temperature stability and uniformity. The stir motor power cord plugs into the back of the bath at the power socket labeled "STIRRER".
- 5) The probe hole is for the temperature controller probe. The probe must be in this hole for the bath to operate.
- 6) A drain valve is provided for ease of removing the fluid media from the bath. Always use a container of adequate size to hold the **full load** of fluid. Some oils are more easily drained at higher temperatures. (See caution note below.)



**WARNING:** *Extreme caution must be maintained to prevent harm to the user or the surrounding environment. Do not exceed a 120°C fluid temperature for draining. The valve could be damaged if 120°C is exceeded. Insulate the container from the floor or other objects that may be damaged by high temperatures as required.*

## 8 General Operation

### 8.1 Heat Transfer Fluid

Many fluids will work with 7012 bath. Choosing a fluid requires consideration of many important characteristics of the fluid. Among these are temperature range, viscosity, specific heat, thermal conductivity, thermal expansion, electrical resistivity, fluid lifetime, safety, and cost.

Use the fluid chart in the manual to choose the type of fluid that is best suited for your intended purpose.

#### 8.1.1 Temperature Range

One of the most important characteristics to consider is the temperature range of the fluid. Few fluids work well throughout the complete temperature range of the bath. The temperature at which the bath is operated must always be within the safe and useful temperature range of the fluid. The lower temperature range of the fluid is determined by the freeze point of the fluid or the temperature at which the viscosity becomes too great. The upper temperature is usually limited by vaporization, flammability, or chemical breakdown of the fluid. Vaporization of the fluid at higher temperatures may affect temperature stability because of cool condensed fluid dripping into the bath from the lid.

The bath temperature should be limited by setting the safety cut-out so that the bath temperature cannot exceed the safe operating temperature limit of the fluid.

#### 8.1.2 Viscosity

Viscosity is a measure of the thickness of a fluid, how easily it can be poured and mixed. Viscosity affects the temperature stability of the bath. With low viscosity, fluid mixing is better which creates a more uniform temperature throughout the bath. This improves the bath response time which allows it to maintain a more constant temperature.

For good control the viscosity should be less than 10 centistokes. 50 centistokes is about the upper limit of allowable viscosity. Viscosities greater than this cause very poor control stability and may also overheat or damage the stirring motor. With oils, viscosity may vary greatly with temperature. Viscosity increases as temperature decreases. When fluid viscosity increases, stability performance of the unit may decrease.

When using fluids with higher viscosities the controller proportional band may need to be increased to compensate for the reduced response time. Otherwise the temperature may begin to oscillate.

Ensure that stirring occurs at all temperatures.

### **8.1.3 Specific Heat**

Specific heat is the measure of the heat storage ability of the fluid. Specific heat, though to a lesser degree, also affects the control stability and the heating and cooling rates. Generally, a lower specific heat causes slightly better control stability and quicker heating and cooling. With fluids with higher specific heat the controller may require a decreased proportional band to compensate for the decrease in sensitivity of the bath temperature to heat input.

### **8.1.4 Thermal Conductivity**

Thermal conductivity measures how easily heat flows through the fluid. Thermal conductivity of the fluid affects the control stability, temperature uniformity, and probe temperature settling time. Fluids with higher conductivity distribute heat more quickly and evenly improving bath performance.

### **8.1.5 Thermal Expansion**

Thermal expansion describes how the volume of the fluid changes with temperature. Thermal expansion of the fluid used must be considered since the increase in fluid volume as the bath temperature changes may cause overflow. Excessive thermal expansion may also be undesirable in applications where constant liquid level is important. Oils typically have significant thermal expansion.

### **8.1.6 Electrical Resistivity**

Electrical resistivity describes how well the fluid insulates against the flow of electric current. In some applications, such as measuring the resistance of bare temperature sensors, it may be important that little or no electrical leakage occur through the fluid. In this case consider a fluid with very high resistivity.

### **8.1.7 Fluid Lifetime**

Many fluids degrade over time because of evaporation, water absorption, gelling, or chemical breakdown. Often the degradation becomes significant near the upper temperature limit of the fluid.

### **8.1.8 Safety**

When choosing a fluid always consider the safety issues associated. Obviously, where there are extreme temperatures there can be danger to personnel and equipment. Fluids may also be hazardous for other reasons. Some fluids may be considered toxic. Contact with eyes, skin, or inhalation of vapors may cause injury. A proper fume hood must be used if hazardous or bothersome vapors are produced.



**WARNING:** *Fluids at high temperatures. May pose danger from BURNS, FIRE, and TOXIC fumes. Use appropriate caution and safety equipment.*

Fluids may be flammable and require special fire safety equipment and procedures. An important characteristic of the fluid to consider is the flash point. The flash point is the temperature at which there is sufficient vapor given off so that when there is sufficient oxygen present and an ignition source is applied the vapor will ignite. This does not necessarily mean that fire will be sustained at the flash point. The flash point may be either of the open cup or closed cup type. Either condition may occur in a bath situation. The closed cup temperature is always the lower of the two. The closed cup represents the contained vapors inside the tank and the open cup represents the vapors escaping the tank. Oxygen and an ignition source will be less available inside the tank.

Environmentally hazardous fluids require special disposal according to applicable federal or local laws after use.

### **8.1.9 Cost**

Cost of bath fluids may vary greatly, from cents per gallon for water to hundreds of dollars per gallon for synthetic oils. Cost may be an important consideration when choosing a fluid.

### **8.1.10 Commonly Used Fluids**

Below is a description of some of the more commonly used fluids and their characteristics.

#### **8.1.10.1 Water**

Water is often used because of its very low cost, availability, and excellent temperature control characteristics. Water has very low viscosity and good thermal conductivity and heat capacity which makes it among the best fluids for control stability at low temperatures. Temperature stability is much poorer at higher temperatures because water condenses on the lid, cools and drips into the bath. Water is safe and relatively inert. The electrical conductivity of water may prevent its use in some applications. Water has a limited temperature range, from a few degrees above 0°C to a few degrees below 100°C. At higher temperatures evaporation becomes significant. Water used in the bath should be distilled or softened to prevent mineral deposits. Consider using an algicide chemical in the water to prevent contamination.

#### **8.1.10.2 Ethylene Glycol**

The temperature range of water may be extended by using a solution of 1 part water and 1 part ethylene glycol (antifreeze). The characteristics of the ethylene glycol-water solution are similar to water. Use caution with ethylene glycol since the fluid is very toxic. Ethylene glycol must be disposed of properly.

#### **8.1.10.3 Methanol**

Methanol or methyl alcohol is often used at low temperatures below 0°C. Methanol is relatively inexpensive, has good control characteristics, and has a



low freeze point. Methanol is very toxic so care must be taken when using and disposing of this fluid.

#### **8.1.10.4 Mineral Oil**

Mineral oil or paraffin oil is often used at moderate temperatures above the range of water. Mineral oil is relatively inexpensive. At lower temperatures mineral oil is quite viscous and control may be poor. At higher temperatures vapor emission becomes significant. The vapors may be dangerous and a fume hood should be used. As with most oils mineral oil will expand as temperature increases so be careful not to fill the bath too full that it overflows when heated. The viscosity and thermal characteristics of mineral oil is poorer than water so temperature stability will not be as good. Mineral oil has very low electrical conductivity. Use caution with mineral oil since it is flammable and may also cause serious injury if inhaled or ingested.

#### **8.1.10.5 Silicone Oils**

Silicone oils are available which offer a much wider operating temperature range than mineral oil. Like most oils, silicone oils have temperature control characteristics which are somewhat poorer than water. The viscosity changes significantly with temperature and thermal expansion also occurs. These oils have very high electrical resistivity. Silicon oils are fairly safe. These oils are relatively expensive.

### **8.1.11 Fluid Characteristics Charts**

Table 2 and Figure 6 have been created to provide help in selecting a heat exchange fluid media for your constant temperature bath. The charts provide both a visual and numerical representation of most of the physical qualities important in making a selection. The list is not all inclusive, many usable fluids may not have been shown in this listing.

#### **8.1.11.1 Limitations and Disclaimer**

Every effort has gone into making these charts accurate, however, the data here does not imply any guarantee of fitness of use for a particular application. Working near the limits of a property such as the flash point or viscosity limit can compromise safety or serviceability. Sources of information sometimes vary for particular properties. Your company's safety policies as well as personal judgment regarding flash points, toxicity, etc. must also be considered. You are responsible for reading the Material Safety Data Sheets and making a judgment here. Cost may require some compromises as well. Hart Scientific cannot be liable for the suitability of application or for any personal injury, damage to equipment, product or facilities in using these fluids.

The charts include information on a variety of fluids which are often used as heat transfer fluid in baths. Because of the temperature range some fluids may not be useful with your bath.

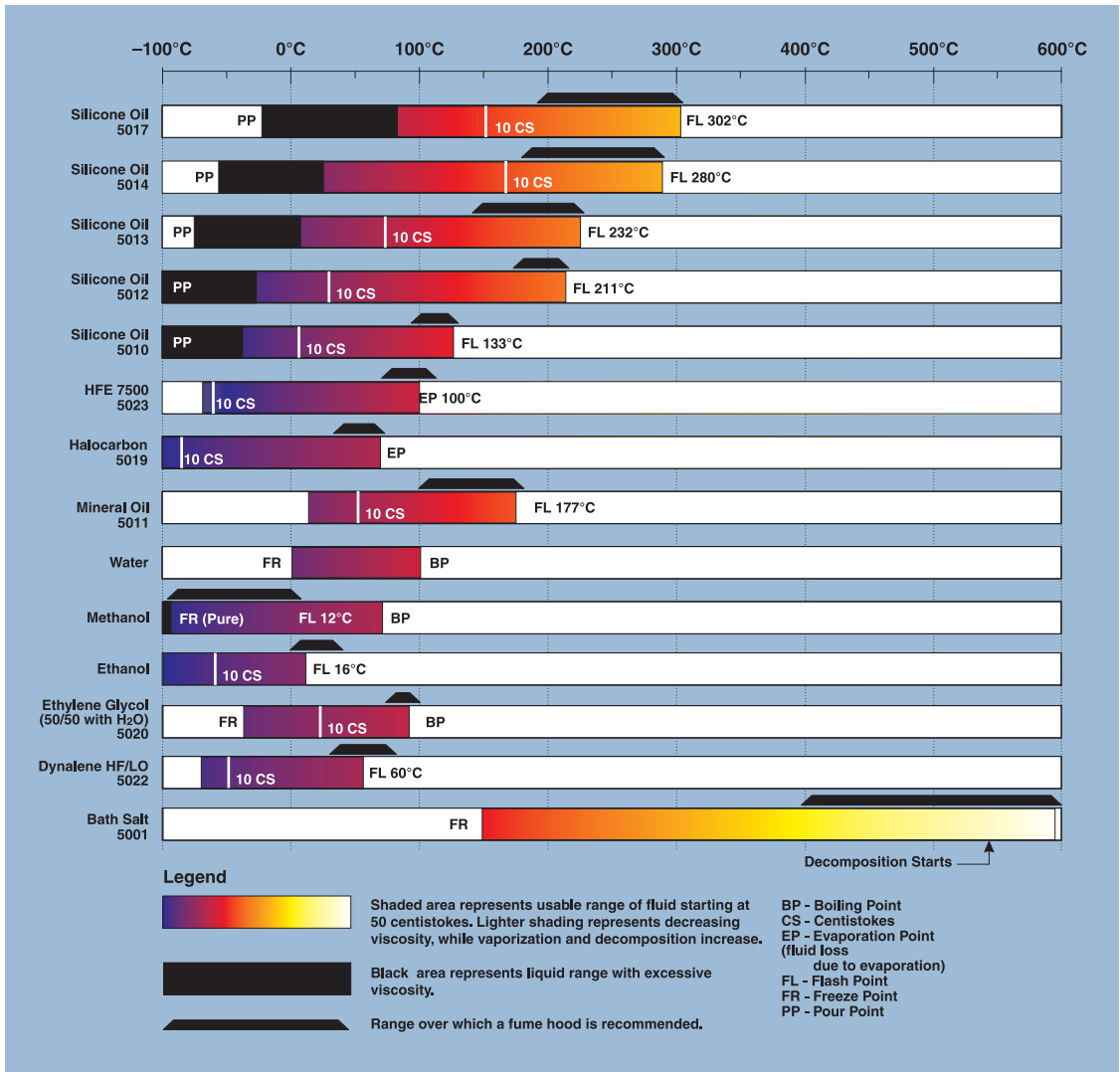

Figure 6 Chart of various bath fluids and their properties

### 8.1.11.2 About the Graph

The fluid graph visually illustrates some of the important qualities of the fluids shown.

**Temperature Range:** The temperature scale is shown in degrees Celsius. A sense of the fluid's general range of application is indicated. Qualities including pour point, freeze point, important viscosity points, flash point, boiling point and others may be shown.

**Table 2** Table of various bath fluids and their properties

Fluid (# = Hart Part No.)	Lower Temperature Limit*	Upper Temperature Limit*	Flash Point	Viscosity (centistokes)	Specific Gravity	Specific Heat (cal/g/°C)	Thermal Conductivity (cal/cm/°C)	Thermal Expansion (cm/cm/°C)	Resistivity (10 <sup>12</sup> Ω-cm)
Halocarbon 0.8 #5019	-90°C (v)**	70°C (e)	NONE	5.7 @ -50°C 0.8 @ 40°C 0.5 @ 70°C	1.71 @ 40°C	0.2	0.0004	0.0011	
Methanol	-96°C (fr)	60°C (b)	54°C	1.3 @ -35°C 0.66 @ 0°C 0.45 @ 20°C	0.810 @ 0°C 0.792 @ 20°C	0.6	0.0005 @ 20°C	0.0014 @ 25°C	
Water	0°C (fr)	95°C (b)	NONE	1 @ 25°C 0.4 @ 75°C	1.00	1.00	0.0014	0.0002 @ 25°C	
Ethylene Glycol—50% #5020	-35°C (fr)	110°C (b)	NONE	7 @ 0°C 2 @ 50°C 0.7 @ 100°C	1.05	0.8 @ 0°C	0.001		
Mineral Oil	40°C (v)	190°C (fl)	190°C	15 @ 75°C 5 @ 125°C	0.87 @ 25°C 0.84 @ 75°C 0.81 @ 125°C	0.48 @ 25°C 0.53 @ 75°C 0.57 @ 125°C	0.00025 @ 25°C	0.0007 @ 50°C	5 @ 25°C
Dow Corning 200.5 Silicone Oil	-40°C (v)**	133°C (fl, cc)	133°C	5 @ 25°C	0.92 @ 25°C	0.4	0.00028 @ 25°C	0.00105	1000 @ 25°C 10 @ 150°C
Dow Corning 200.10 #5012	-35°C (v)**	165°C (fl, cc)	165°C	10 @ 25°C 3 @ 135°C	0.934 @ 25°C	0.43 @ 40°C 0.45 @ 100°C 0.482 @ 200°C	0.00032 @ 25°C	0.00108	1000 @ 25°C 50 @ 150°C
Dow Corning 200.20 #5013	7°C (v)	230°C (fl, cc)	230°C	20 @ 25°C	0.949 @ 25°C	0.370 @ 40°C 0.393 @ 100°C 0.420 @ 200°C	0.00034 @ 25°C	0.00107	1000 @ 25°C 50 @ 150°C
Dow Corning 200.50 Silicone Oil	25°C (v)	280°C (fl, cc)	280°C	20 @ 25°C	0.96 @ 25°C	0.4	0.00037 @ 25°C	0.00104	1000 @ 25°C 50 @ 150°C
Dow Corning 550 #5016	70°C (v)	232°C (fl, cc) 300°C (fl, cc)	232°C	50 @ 70°C 10 @ 104°C	1.07 @ 25°C	0.358 @ 40°C 0.386 @ 100°C 0.433 @ 200°C	0.00035 @ 25°C	0.00075	100 @ 25°C 1 @ 150°C
Dow Corning 710 #5017	80°C (v)	302°C (fl, cc)	302°C	50 @ 80°C 7 @ 204°C	1.11 @ 25°C	0.363 @ 40°C 0.454 @ 100°C 0.505 @ 200°C	0.00035 @ 25°C	0.00077	100 @ 25°C 1 @ 150°C
Dow Corning 210-H Silicone Oil	66°C (v)	315°C (fl, cc)	315°C	50 @ 66°C 14 @ 204°C	0.96 @ 25°C	0.34 @ 100°C	0.0003	0.00095	100 @ 25°C 1 @ 150°C
Heat Transfer Salt #5001	145°C (fr)	530°C	NONE	34 @ 150°C 6.5 @ 300°C 2.4 @ 500°C	2.0 @ 150°C 1.9 @ 300°C 1.7 @ 500°C	0.33	0.0014	0.00041	1.7 Ω /cm <sup>3</sup>

\*Limiting Factors — b - boiling point e - high evaporation fl - flash point fr - freeze point v - viscosity — Flash point test oc = open cup cc = closed cup

\*\*Very low water solubility, ice will form as a slush from condensation below freezing.

**Freezing Point:** The freezing point of a fluid is an obvious limitation to stirring. As the freezing point is approached high viscosity may also limit good stirring.

**Pour Point:** This represents a handling limit for the fluid.

**Viscosity:** Points shown are at 50 and 10 centistokes. Greater than 50 centistokes stirring is very poor and unsatisfactory for bath applications. At 10 centistokes and below optimum stirring can occur. These are rules of thumb which have been useful for most applications.

**Fume Point:** The point at which a fume hood should be used. This point is very subjective in nature and is impacted by individual tolerance to different fumes and smells, how well the bath is covered, the surface area of the fluid in the bath, the size and ventilation of the facility where the bath is located and others. We assume the bath is well covered at this point. This is also subject to company policy.

**Flash Point:** The point at which ignition may occur. See flash point discussion in Section 8.1.8. The point shown may be either the open or closed cup flash point.

**Boiling Point:** At the boiling point of the fluid the temperature stability is difficult to maintain. Fuming is excessive. Excessive amounts of heater power may be required because of the heat of vaporization.

**Decomposition:** All high temperature fluids may reach a temperature point at which decomposition of some form will begin. While it always begins slowly at some lower temperature, the rate can increase to the point of danger or impracticality at a higher temperature.

## 8.2 Stirring

Stirring of the bath fluid is very important for stable temperature control. The fluid must be mixed well for good temperature uniformity and fast controller response. The stirrer is precisely adjusted for optimum performance.

## 8.3 Power

Power to the bath is provided by an AC mains supply. Refer to Section 3.1, Specifications, for power requirement details. Power to the bath passes through a filter to prevent switching spikes from being transmitted to other equipment. Refer to and read the WARNING at the front of this manual concerning brown-out and over voltage protection.

To turn on the bath switch the control panel power switch to the ON position. The stir motor will turn on, the LED display will begin to show the bath temperature, and the heater will turn on or off until the bath temperature reaches the programmed set-point.

When powered on the control panel display briefly shows a four digit number. This number indicates the number of times power has been applied to the bath. Also briefly displayed is data which indicates the controller hardware configuration. This data is used in some circumstances for diagnostic purposes.

## 8.4 Heater

The power to the bath heater is precisely controlled by the temperature controller to maintain a constant bath temperature. Power is controlled by periodically switching the heater on for a certain amount of time using a solid-state relay.

The front panel red/green control indicator shows the state of the heater. The control indicator glows red when the heater is on and glows green when the heater is off. The indicator will pulse constantly when the bath is maintaining a stable temperature.

The heater has two power level settings. The "HIGH" heater power setting is used to quickly heat up the bath fluid to the desired operating temperature. The "HIGH" heater power setting may also be required for control at high temperatures. The "LOW" setting is used for control at lower temperatures and for scanning at slower rates. When controlling at the "HIGH" heater power setting instead of "LOW" the proportional band may need to be increased (typically by a factor of four) to compensate for the increase in power gain. Otherwise the temperature may oscillate.

## **8.5 Cooling**

The back pressure control valve limits the cooling capacity of the unit. It will normally be open all the way (full CCW) for temperature slewing and operation. If during operation the front panel meter indicates excessive cooling, this valve is closed partially (turn CW) until the percentage of heating to cooling is brought into line. It is necessary to wait a few minutes after each adjustment until the system settles.

Set the COOLING TEMPERATURE according to the cooling label. The cooling temperature should NOT be set above 90 psig. At about 45°C the refrigeration will not be required as there is sufficient cooling to the room. Wait a few minutes after each adjustment until the system establishes itself. Readjust if required after settling for a while.

For maximum cooling for slewing to lower temperatures, the BACK PRESSURE valve should be fully open and the COOLING TEMPERATURE set to 0°C. Readjust higher or lower as required after set temperature is reached.

## **8.6 Fluid Drain**

The drain at the back of the bath (see Figure 4 and Figure 5 on pages 24 and 25) may be used to remove fluid from the bath. During operation of the bath the drain must be closed.

## **8.7 Temperature Controller**

The bath temperature is controlled by Hart Scientific's unique hybrid digital/analog temperature controller. The controller offers the tight control stability of an analog temperature controller as well as the flexibility and programmability of a digital controller.

The bath temperature is monitored with a linear thermistor sensor in the control probe. The signal is electronically compared with the programmable reference

signal, amplified, and then fed to a pulse-width modulator circuit which controls the amount of power applied to the bath heater.

The bath is operable within the temperature range given in the specifications. For protection against solid-state relay failure or other circuit failure, the microcontroller automatically turns off the heater with a second mechanical relay anytime the bath temperature is more than a certain amount above the set-point temperature. As a second protection device, the controller is also equipped with a separate thermocouple temperature monitoring circuit which shuts off the heater if the temperature exceeds the cut-out set-point.

The controller allows the operator to set the bath temperature with high resolution, set the cut-out, adjust the proportional band, monitor the heater output power, and program the controller configuration and calibration parameters. The controller may be operated in temperature units of degrees Celsius or Fahrenheit. The controller is operated and programmed from the front control panel using the four key switches and digital LED display. The controller may also be optionally equipped with a serial RS-232 or IEEE-488 GPIB digital interface for remote operation. Operation of the controller using the front control panel is discussed in Section 9. Operation using the digital interfaces is discussed in Section 10.

When the controller is set to a new set-point the bath heats or cool to the new temperature. Once the new temperature is reached the bath usually takes 10-15 minutes for the temperature to settle and stabilize. There may be a small overshoot or undershoot of about 0.5°C.

## 9 Controller Operation

This section discusses in detail how to operate the bath temperature controller using the front control panel. Using the front panel key switches and LED display the user may monitor the bath temperature, set the temperature set-point in degrees C or F, monitor the heater output power, adjust the controller proportional band, set the cutout set-point, and program the probe calibration parameters, operating parameters, serial and IEEE-488 interface configuration, and controller calibration parameters. Operation is summarized in Figure 7.

### 9.1 Bath Temperature

The digital LED display on the front panel allows direct viewing of the actual bath temperature. This temperature value is what is normally shown on the display. The units, C or F, of the temperature value are displayed at the right. For example,

 *Bath temperature in degrees Celsius*

The temperature display function may be accessed from any other function by pressing the “EXIT” button.

### 9.2 Reset Cutout

If the over-temperature cutout has been triggered then the temperature display will alternately flash,

 *Indicates cutout condition*

The message continues to flash until the temperature is reduced and the cutout is reset.

The cutout has two modes — automatic reset and manual reset. The mode determines how the cutout is reset which allows the bath to heat up again. When in automatic mode, the cutout resets itself as soon as the temperature is lowered below the cutout set-point. With manual reset mode the cutout must be reset by the operator after the temperature falls below the set-point.

When the cutout is active and the cutout mode is set to manual (“reset”) then the display will flash “cut-out” until the user resets the cutout. To access the reset cutout function press the “SET” button.



*Access cutout reset function*

The display will indicate the reset function.

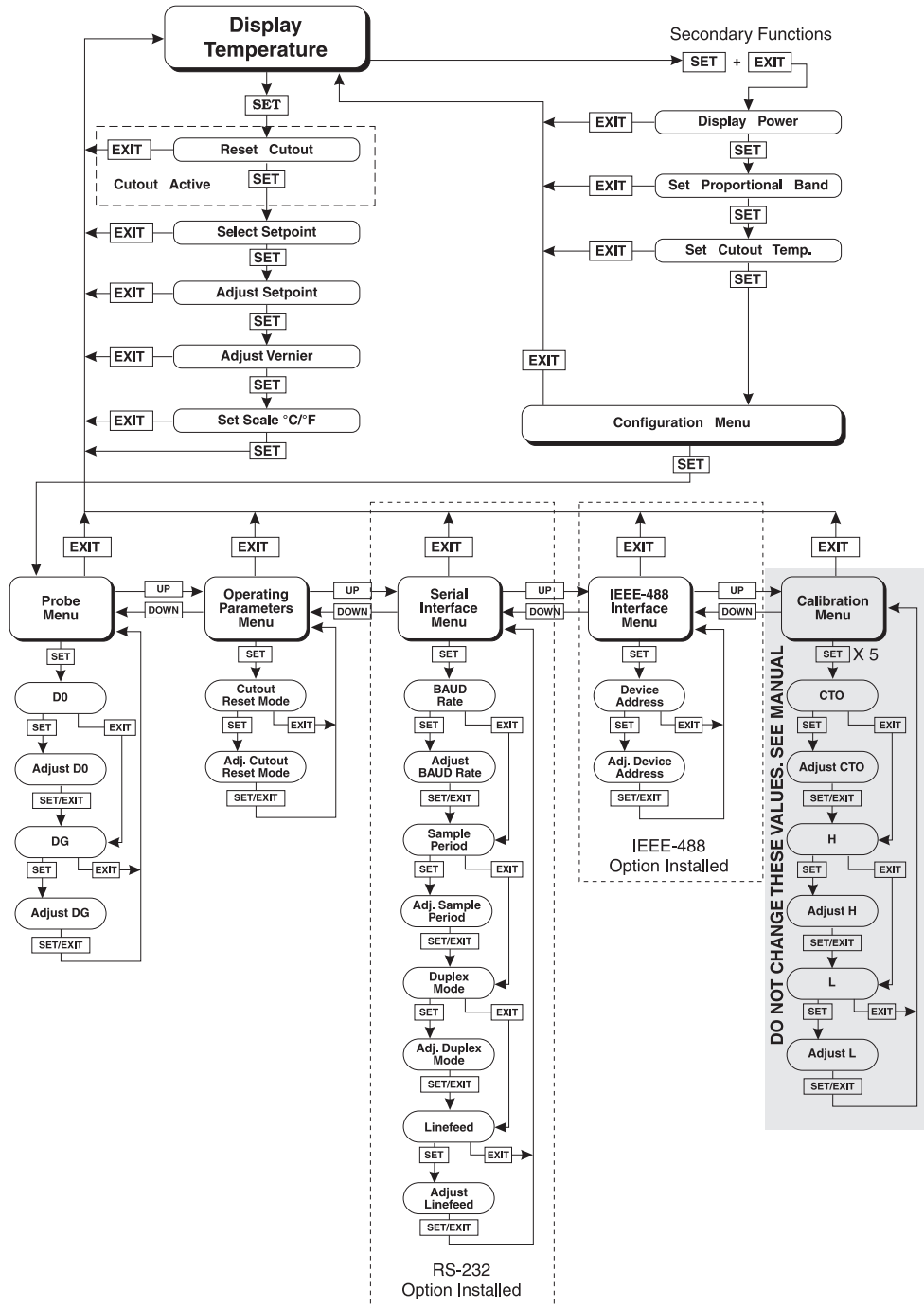

**Figure 7** Controller Operation Flowchart





*Cutout reset function*

Press “SET” once more to reset the cutout.



*Reset cutout*

This switches the display to the set temperature function. To return to displaying the temperature press the “EXIT” button. If the cutout is still in the over-temperature fault condition the display continues to flash “ $\text{CUT-OFF}$ ”. The bath temperature must drop a few degrees below the cutout set-point before the cutout can be reset.

## 9.3 Temperature Set-point

The bath temperature can be set to any value within the range and with resolution as given in the specifications. The temperature range of the particular fluid used in the bath must be known by the operator and the bath should only be operated well below the upper temperature limit of the liquid. In addition, the cutout temperature should also be set below the upper limit of the fluid.

Setting the bath temperature involves three steps: (1) select the set-point memory, (2) adjust the set-point value, and (3) adjust the vernier if desired.

### 9.3.1 Programmable Set-points

The controller stores 8 set-point temperatures in memory. The set-points can be quickly recalled to conveniently set the bath to a previously programmed temperature set-point.

To set the bath temperature one must first select the set-point memory. This function is accessed from the temperature display function by pressing “SET”. The number of the set-point memory currently being used is shown at the left on the display followed by the current set-point value.

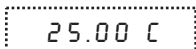

*Bath temperature in degrees Celsius*



*Access set-point memory*

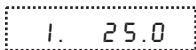

*Set-point memory 1, 25.0°C currently used*

To change the set-point memory press “UP” or “DOWN”.

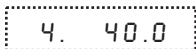

*New set-point memory 4, 40.0°C*

Press “SET” to accept the new selection and access the set-point value.



*Accept selected set-point memory*

### 9.3.2 Set-point Value

The set-point value may be adjusted after selecting the set-point memory and pressing “SET”. The set-point value is displayed with the units, C or F, at the left.

 *Set-point 4 value in °C*

If the set-point value need not be changed then press “EXIT” to resume displaying the bath temperature. Press “UP” or “DOWN” to adjust the set-point value.

 *New set-point value*

When the desired set-point value is reached press “SET” to accept the new value and access the set-point vernier. If “EXIT” is pressed instead then any changes made to the set-point will be ignored.



*Accept new set-point value*

### 9.3.3 Set-point Vernier

The set-point value can only be set with a resolution of 0.002°C. The user may want to adjust the set-point slightly to achieve a precise bath temperature. The set-point vernier allows one to adjust the temperature below or above the set-point by a small amount with very high resolution. Each of the 8 stored set-points has an associated vernier setting. The vernier is accessed from the set-point by pressing “SET”. The vernier setting is displayed as a 6 digit number with five digits after the decimal point. This is a temperature offset in degrees of the selected units, C or F.

 *Current vernier value in °C*

To adjust the vernier press “UP” or “DOWN”. Unlike most functions the vernier setting has immediate effect as the vernier is adjusted. “SET” need not be pressed. This allows one to continually adjust the bath temperature with the vernier as it is displayed.

 *New vernier setting*

Next press “EXIT” to return to the temperature display or “SET” to access the temperature scale units selection.



*Access scale units*

## 9.4 Temperature Scale Units

The temperature scale units of the controller may be set by the user to degrees Celsius (°C) or Fahrenheit (°F). These units are used in displaying the bath temperature, set-point, vernier, proportional band, and cutout set-point.

The temperature scale units selection is accessed after the vernier adjustment function by pressing “SET”. From the temperature display function access the units selection by pressing “SET” 4 times.

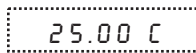

*Bath temperature*



*Access set-point memory*

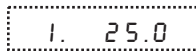

*Set-point memory*



*Access set-point value*

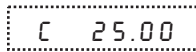

*Set-point value*



*Access vernier*



*Vernier setting*



*Access scale units selection*

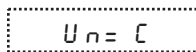

*Scale units currently selected*

Press “UP” or “DOWN” to change the units.

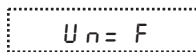

*New units selected*

Press “SET” to accept the new selection and resume displaying the bath temperature.



*Set the new units and resume temperature display*

## 9.5 Secondary Menu

Functions which are used less often are accessed within the secondary menu. The secondary menu is accessed by pressing “SET” and “EXIT” simultaneously and then releasing. The first function in the secondary menu is the heater power display.

## 9.6 Heater Power

The temperature controller controls the temperature of the bath by pulsing the heater on and off. The total power being applied to the heater is determined by the duty cycle or the ratio of heater on time to the pulse cycle time. This value may be estimated by watching the red/green control indicator light or read directly from the digital display. By knowing the amount of heating to the bath the user can tell if the bath is heating up to the set-point, cooling down, or controlling at a constant temperature. Monitoring the percent heater power will let the user know how stable the bath temperature is. With good control stability the percent heating power should not fluctuate more than  $\pm 1\%$  within one minute.

The heater power display is accessed in the secondary menu. Press “SET” and “EXIT” simultaneously and release. The heater power will be displayed as a percentage of full power.

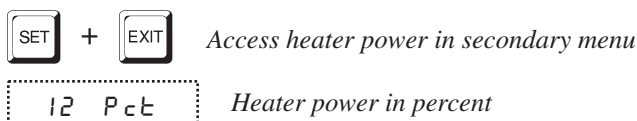

To exit out of the secondary menu press “EXIT”. To continue on to the proportional band setting function press “SET”.

## 9.7 Proportional Band

In a proportional controller such as this the heater output power is proportional to the bath temperature over a limited range of temperatures around the set-point. This range of temperature is called the proportional band. At the bottom of the proportional band the heater output is 100%. At the top of the proportional band the heater output is 0. Thus as the bath temperature rises the heater power is reduced, which consequently tends to lower the temperature back down. In this way the temperature is maintained at a fairly constant temperature.

The temperature stability of the bath depends on the width of the proportional band. See Figure 8. If the band is too wide the bath temperature will deviate excessively from the set-point due to varying external conditions. This is because the power output changes very little with temperature and the controller cannot respond very well to changing conditions or noise in the system. If the propor-

tional band is too narrow the bath temperature may swing back and forth because the controller overreacts to temperature variations. For best control stability the proportional band must be set for the optimum width.

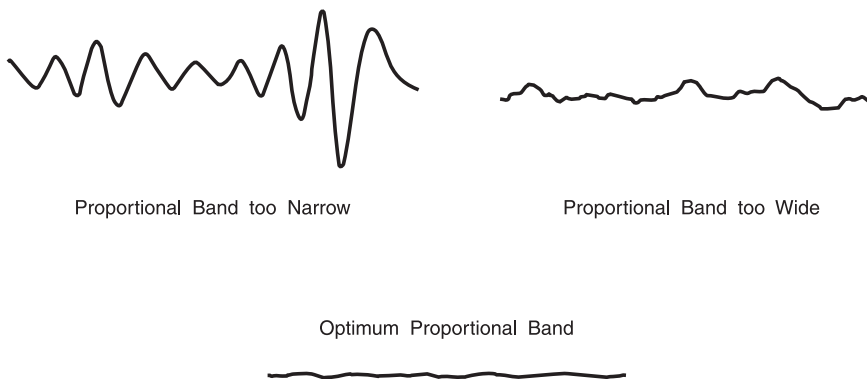

**Figure 8** Bath temperature fluctuation at various proportional band settings

The optimum proportional band width depends on several factors among which are fluid volume, fluid characteristics (viscosity, specific heat, thermal conductivity), heater power setting, operating temperature, and stirring. Thus the proportional band width may require adjustment for best bath stability when any of these conditions change. Of these, the most significant factors affecting the optimum proportional band width are heater power setting and fluid viscosity. The proportional band should be wider when the higher power setting is used so that the change in output power per change in temperature remains the same.



**Table 3** Proportional Band — Fluid Table

Fluid	Temperature	Heater Setting	Proportional Band	Stability
Water	30.0°C	Low	0.04°C	±0.0004°C
Water	60.0°C	Low	0.04°C	±0.001°C
Eth-Gly 50%	35.0°C	Low	0.05°C	±0.0005°C
Eth-Gly 50%	60.0°C	Low	0.05°C	±0.001°C
Eth-Gly 50%	100.0°C	High	0.4°C	±0.007°C
Oil	35.0°C	Low	0.1°C	±0.003°C
Oil	60.0°C	Low	0.2°C	±0.002°C
Oil	100°C	Low	0.2°C	±0.003°C

The proportional band should also be wider when the fluid viscosity is higher because of the increased response time.

The proportional band width is easily adjusted from the bath front panel. The width may be set to discrete values in degrees C or F depending on the selected units. The optimum proportional band width setting may be determined by monitoring the stability with a high resolution thermometer or with the controller percent output power display. Narrow the proportional band width to the point at which the bath temperature begins to oscillate and then increase the band width from this point to 3 or 4 times wider. Table 3 lists typical proportional band settings for optimum performance with a variety of fluids at selected temperatures.

The proportional band adjustment may be accessed within the secondary menu. Press "SET" and "EXIT" to enter the secondary menu and show the heater power. Then press "SET" to access the proportional band.

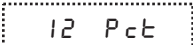
 +  *Access heater power in secondary menu*  
 *Heater power in percent*

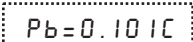
 *Access proportional band*  
 *Proportional band setting*

To change the proportional band press "UP" or "DOWN".

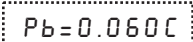
 *New proportional band setting*

To accept the new setting and access the cutout set-point press "SET". Pressing "EXIT" will exit the secondary menu ignoring any changes just made to the proportional band value.

 *Accept the new proportional band setting*

## 9.8 Cutout

As a protection against software or hardware fault, shorted heater triac, or user error, the bath is equipped with an adjustable heater cutout device that shuts off power to the heater if the bath temperature exceeds a set value. This protects the heater and bath materials from excessive temperatures and, most importantly, protects the bath fluids from being heated beyond the safe operating temperature preventing hazardous vaporization, breakdown, or ignition of the liquid. The cutout temperature is programmable by the operator from the front panel of the controller. It must always be set below the upper temperature limit

of the fluid and no more than 10 degrees above the upper temperature limit of the bath.

If the cutout is activated because of excessive bath temperature, power to the heater shuts off and the bath cools. The bath cools until it reaches a few degrees below the cutout set-point temperature. At this point the action of the cutout is determined by the setting of the cutout mode parameter. The cutout has two selectable modes — automatic reset or manual reset. If the mode is set to automatic, the cutout automatically resets itself when the bath temperature falls below the reset temperature allowing the bath to heat up again. If the mode is set to manual, the heater remains disabled until the user manually resets the cutout.

The cutout set-point may be accessed within the secondary menu. Press “SET” and “EXIT” to enter the secondary menu and show the heater power. Then press “SET” twice to access the cutout set-point.

 +  *Access heater power in secondary menu*

 *Heater power in percent*

 *Access proportional band*

 *Proportional band setting*

 *Access cutout set-point*

 *cutout set-point*

To change the cutout set-point press “UP” or “DOWN”.

 *New cutout set-point*

To accept the new cutout set-point press “SET”.

 *Accept cutout set-point*

The next function is the configuration menu. Press “EXIT” to resume displaying the bath temperature.

## 9.9 Controller Configuration

The controller has a number of configuration and operating options and calibration parameters which are programmable via the front panel. These are accessed from the secondary menu after the cutout set-point function by pressing

“SET.” There are 5 sets of configuration parameters — probe parameters, operating parameters, serial interface parameters, IEEE-488 interface parameters, and controller calibration parameters. The menus are selected using the “UP” and “DOWN” keys and then pressing “SET”.

## 9.10 Probe Parameters

The probe parameter menu is indicated by,

P r O b E *Probe parameters menu*

Press “SET” to enter the menu. The probe parameters menu contains the parameters, D0 and Dg, which characterize the resistance-temperature relationship of the thermistor control probe. These parameters may be adjusted to improve the accuracy of the bath. This procedure is explained in detail in Section 11.

The probe parameters are accessed by pressing “SET” after the name of the parameter is displayed. The value of the parameter may be changed using the “UP” and “DOWN” buttons. After the desired value is reached press “SET” to set the parameter to the new value. Pressing “EXIT” will cause the parameter to be skipped ignoring any changes that may have been made.

### 9.10.1 D0

This probe parameter refers to the resistance of the control probe at 0°C. Normally this is set for -25.2290 ohms.

### 9.10.2 Dg

This probe parameter refers to the average sensitivity of the probe between 0 and 100°C. Normally this is set for 186.9740

## 9.11 Operating Parameters

The operating parameters menu is indicated by,

P A r *Operating parameters menu*

Press “SET” to enter the menu. The operating parameters menu contains the cutout reset mode setting.

### 9.11.1 Cutout Reset Mode

The cutout reset mode determines whether the cutout resets automatically when the bath temperature drops to a safe value or must be manually reset by the operator.

The parameter is indicated by,



`CtOrSt` *Cutout reset mode parameter*

Press “SET” to access the parameter setting. Normally the cutout is set for manual mode.

`Cto=rSt` *Cutout set for manual reset*

To change to automatic reset mode press “UP” and then “SET”.

`Cto=AutO` *Cutout set for automatic reset*

## 9.12 Serial Interface Parameters

The 7012 bath may optionally be fitted with an RS-232 interface. The serial RS-232 interface parameters menu is indicated by,

`SERIAL` *Serial RS-232 interface parameters menu*

The serial interface parameters menu contains parameters which determine the operation of the serial interface. These controls only apply to baths fitted with the serial interface. The parameters in the menu are — BAUD rate, sample period, duplex mode, and linefeed.

### 9.12.1 Baud Rate

The baud rate is the first parameter in the menu. The baud rate setting determines the serial communications transmission rate.

The baud rate parameter is indicated by,

`BAUD` *Serial baud rate parameter*

Press “SET” to choose to set the baud rate. The current baud rate value will then be displayed.

`1200 b` *Current baud rate*

The baud rate of the bath serial communications may be programmed to 300,600,1200, or 2400 baud. Use “UP” or “DOWN” to change the baud rate value.

`2400 b` *New baud rate*

Press “SET” to set the baud rate to the new value or “EXIT” to abort the operation and skip to the next parameter in the menu.

### 9.12.2 Sample Period

The sample period is the next parameter in the serial interface parameter menu. The sample period is the time period in seconds between temperature measurements transmitted from the serial interface. If the sample rate is set to 5, the bath transmits the current measurement over the serial interface approximately every five seconds. The automatic sampling is disabled with a sample period of 0. The sample period is indicated by,

`SAMPLE` *Serial sample period parameter*

Press “SET” to choose to set the sample period. The current sample period value will be displayed.

`SR= 1` *Current sample period (seconds)*

Adjust the value with “UP” or “DOWN” and then use “SET” to set the sample rate to the displayed value.

`SR= 60` *New sample period*

### 9.12.3 Duplex Mode

The next parameter is the duplex mode. The duplex mode may be set to full duplex or half duplex. With full duplex any commands received by the bath via the serial interface are immediately echoed or transmitted back to the device of origin. With half duplex the commands are executed but not echoed. The duplex mode parameter is indicated by,

`DUPLEX` *Serial duplex mode parameter*

Press “SET” to access the mode setting.

`DUP=FULL` *Current duplex mode setting*

The mode may be changed using “UP” or “DOWN” and pressing “SET”.

`DUP=HALF` *New duplex mode setting*

### 9.12.4 Linefeed

The final parameter in the serial interface menu is the linefeed mode. This parameter enables (on) or disables (off) transmission of a linefeed character (LF, ASCII 10) after transmission of any carriage-return. The linefeed parameter is indicated by,

`LF` *Serial linefeed parameter*

Press “SET” to access the linefeed parameter.

`LF= 0 n` *Current linefeed setting*

The mode may be changed using “UP” or “DOWN” and pressing “SET”.

`LF= 0 FF` *New linefeed setting*

## 9.13 IEEE-488 Parameters

Baths may optionally be fitted with an IEEE-488 GPIB interface. In this case the user may set the interface address within the IEEE-488 parameter menu. This menu does not appear on baths not fitted with the interface. The menu is indicated by,

`IEEE` *IEEE-488 parameters menu*

Press “SET” to enter the menu.

### 9.13.1 IEEE-488 Address

The IEEE-488 interface must be configured to use the same address as the external communicating device. The address is indicated by,

`Addr E55` *IEEE-488 interface address*

Press “SET” to access the address setting.

`Addr= 22` *Current IEEE-488 interface address*

Adjust the value with “UP” or “DOWN” and then use “SET” to set the address to the displayed value.

`Addr= 15` *New IEEE-488 interface address*

## 9.14 Calibration Parameters

The operator of the bath controller has access to a number of the bath calibration constants namely CTO, H, and L. These values are set at the factory and must not be altered. The correct values are important to the accuracy and proper and safe operation of the bath. Access to these parameters is available to the user only so that in the event that the controller’s memory fails the user may restore these values to the factory settings. The user should have a list of these constants and their settings with the manual.

*DO NOT change the values of the bath calibration constants from the factory set values. The correct setting of these parameters is important to the safety and proper operation of the bath.*

The calibration parameters menu is indicated by,



Press “SET” five times to enter the menu.

### **9.14.1 CTO**

Parameter CTO sets the calibration of the over-temperature cutout. This is not adjustable by software but is adjusted with an internal potentiometer. For the 7012 baths this parameter should read between 120.

### **9.14.2 H and L**

These parameters set the upper and lower set-point limits of the bath. **DO NOT** change the values of these parameters from the factory set values. To do so may present danger of the bath exceeding its temperature range causing damage or fire.

## 10 Digital Communication Interface

If supplied with the option, the 7012 bath is capable of communicating with and being controlled by other equipment through the digital interface. Two types of digital interface are available — the RS-232 serial interface and the IEEE-488 GPIB interface.

With a digital interface the bath may be connected to a computer or other equipment. This allows the user to set the bath temperature, monitor the temperature, and access any of the other controller functions, all using remote communications equipment. In addition the heater power setting and cooling capacity may be controlled using the interface. To enable the heater to be switched to high using the interface the “HEATER” switch must be set to the “LOW” position. The cooling power switch must be set to OFF to enable remote control.

### 10.1 Serial Communications

The bath may be installed with an RS-232 serial interface that allows serial digital communications over fairly long distances. With the serial interface the user may access any of the functions, parameters and settings discussed in Section 9 with the exception of the BAUD rate setting. The serial interface uses 8 data bits, 1 stop bit, and no parity.

#### 10.1.1 Wiring

The serial communications cable attaches to the bath through the DB-9 connector at the back of the instrument. Figure 9 shows the pin-out of this connector and suggested cable wiring. To eliminate noise, the serial cable should be shielded with low resistance between the connector (DB-9) and the shield.

#### 10.1.2 Setup

Before operation the serial interface of the bath must first be set

#### RS-232 Cable Wiring for IBM PC and Compatibles

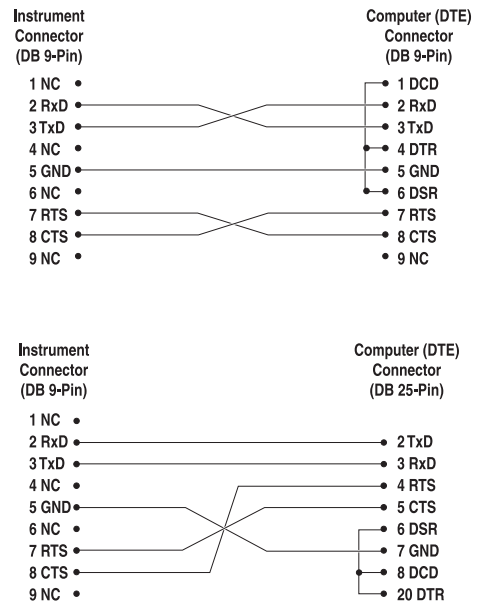

Figure 9 Serial Communications Cable Wiring

up by programming the baud rate and other configuration parameters. These parameters are programmed within the serial interface menu.

To enter the serial parameter programming mode first press "EXIT" while pressing "SET" and release to enter the secondary menu. Press "SET" repeatedly until the display reads "P r o b E". This is the menu selection. Press "UP" repeatedly until the serial interface menu is indicated with "S E R I A L". Finally press "SET" to enter the serial parameter menu. In the serial interface parameters menu are the baud rate, the sample rate, the duplex mode, and the linefeed parameter.

### **10.1.2.1 Baud rate**

The baud rate is the first parameter in the menu. The display will prompt with the baud rate parameter by showing "B A U D". Press "SET" to choose to set the baud rate. The current baud rate value will then be displayed. The baud rate of the 7012 serial communications may be programmed to 300,600,1200, or 2400 baud. The baud rate is pre-programmed to 1200 baud. Use "UP" or "DOWN" to change the baud rate value. Press "SET" to set the baud rate to the new value or "EXIT" to abort the operation and skip to the next parameter in the menu.

### **10.1.2.2 Sample Period**

The sample period is the next parameter in the menu and prompted with "S A M- P L E". The sample period is the time period in seconds between temperature measurements transmitted from the serial interface. If the sample rate is set to 5, the 7012 transmits the current measurement over the serial interface approximately every five seconds. The automatic sampling is disabled with a sample period of 0. Press "SET" to choose to set the sample period. Adjust the period with "UP" or "DOWN" and then use "SET" to set the sample rate to the displayed value.

### **10.1.2.3 Duplex Mode**

The next parameter is the duplex mode indicated with "D U P L". The duplex mode may be set to half duplex ("H A L F") or full duplex ("F U L L"). With full duplex any commands received by the thermometer via the serial interface are immediately echoed or transmitted back to the device of origin. With half duplex the commands are executed but not echoed. The default setting is full duplex. The mode may be changed using "UP" or "DOWN" and pressing "SET".

### **10.1.2.4 Linefeed**

The final parameter in the serial interface menu is the linefeed mode. This parameter enables ("On") or disables ("OFF") transmission of a linefeed character (LF, ASCII 10) after transmission of any carriage-return. The default setting is with linefeed on. The mode may be changed using "UP" or "DOWN" and pressing "SET".

### 10.1.3 Serial Operation

Once the cable has been attached and the interface set up properly the controller immediately begins transmitting temperature readings at the programmed rate. The set-point and other commands may be sent to the bath via the serial interface to set the bath and view or program the various parameters. The interface commands are discussed in Section 10.3. All commands are ASCII character strings terminated with a carriage-return character (CR, ASCII 13).

## 10.2 IEEE-488 Communication

The IEEE-488 interface is available as an option. Baths supplied with this option may be connected to a GPIB type communication bus which allows many instruments to be connected and controlled simultaneously. To eliminate noise, the GPIB cable should be shielded.

### 10.2.1 Setup

To use the IEEE-488 interface first connect an IEEE-488 standard cable to the back of the bath. Next set the device address. This parameter is programmed within the IEEE-488 interface menu.

To enter the IEEE-488 parameter programming menu first press "EXIT" while pressing "SET" and release to enter the secondary menu. Press "SET" repeatedly until the display reaches "P R O B E". This is the menu selection. Press "UP" repeatedly until the IEEE-488 interface menu is indicated with "I E E E". Press "SET" to enter the IEEE-488 parameter menu. The IEEE-488 menu contains the IEEE-488 address parameter.

#### 10.2.1.1 IEEE-488 Interface Address

The IEEE-488 address is prompted with "A D D R E S S". Press "SET" to program the address. The default address is 22. Change the device address of the bath if necessary to match the address used by the communication equipment by pressing "UP" or "DOWN" and then "SET".

### 10.2.2 IEEE-488 Operation

Commands may now be sent via the IEEE-488 interface to read or set the temperature or access other controller functions. All commands are ASCII character strings and are terminated with a carriage-return (CR, ASCII 13). Interface commands are listed below.

## 10.3 Interface Commands

The various commands for accessing the bath controller functions via the digital interfaces are listed in this section (see Table 4). These commands are used with both the RS-232 serial interface and the IEEE-488 GPIB interface. In either case the commands are terminated with a carriage-return character. The interface makes no distinction between upper and lower case letters, hence either

**Table 4** Interface Command Summary.

Command Description	Command Format	Command Example	Returned	Returned Example	Acceptable Values
<b>Display Temperature</b>					
Read current set-point	s[etpoint]	s	set: 9999.99 {C or F}	set: 105.00 C	
Set current set-point to <i>n</i>	s[etpoint]= <i>n</i>	s=100			Instrument Range
Read vernier	v[ernier]	v	v: 9.99999	v: 0.00000	
Set vernier to <i>n</i>	v[ernier]= <i>n</i>	v=.00001			Depends on Configuration
Read temperature	t[emperature]	t	t: 9999.99 {C or F}	t: 55.69 C	
Read temperature units	u[nits]	u	u: x	u: c	
<b>Set temperature units:</b>	<b>u[nits]=c/f</b>				C or F
Set temperature units to Celsius	u[nits]=c	u=c			
Set temperature units to Fahrenheit	u[nits]=f	u=f			
<b>Secondary Menu</b>					
Read proportional band setting	pr[op-band]	pr	pr: 999.9	pr: 15.9	
Set proportional band to <i>n</i>	pr[op-band]= <i>n</i>	pr=8.83			Depends on Configuration
Read cutout setting	c[utout]	c	c: 9999 {x},{xxx}	c: 620 C, in	
<b>Set cutout setting:</b>	<b>c[utout]=<i>n</i>/r[eset]</b>				
Set cutout to <i>n</i> degrees	c[utout]= <i>n</i>	c=500			Temperature Range
Reset cutout now	c[utout]=r[eset]	c=r			
Read heater power (duty cycle)	po[wer]	po	po: 9999	po: 1	±100
<b>Configuration Menu</b>					
<b>Probe Menu</b>					
Read D0 calibration parameter	*d0	*d0	d0: 999.9999	d0: -25.2290	
Set D0 calibration parameter to <i>n</i>	*d0= <i>n</i>	*d0=-25.2290			-999.9999 to 999.9999
Read DG calibration parameter	*dg	*dg	dg: 999.9999	dg:186.9740	
Set DG calibration parameter to <i>n</i>	*dg= <i>n</i>	*dg=186.9740			-999.9999 to 999.9999
<b>Operating Parameters Menu</b>					
Read cutout mode	cm[ode]	cm	cm: {xxxx}	cm: AUTO	
<b>Set cutout mode:</b>	<b>cm[ode]=r[eset]/a[uto]</b>				RESET or AUTO
Set cutout to be reset manually-	cm[ode]=r[eset]	cm=r			
Set cutout to be reset automatically	cm[ode]=a[uto]	cm=a			
<b>Serial Interface Menu</b>					
Read serial sample setting	sa[mple]	sa	sa: 9	sa: 1	



Digital Communications Commands continued

Command Description	Command Format	Command Example	Returned	Returned Example	Acceptable Values
Set serial sampling setting to <i>n</i> seconds	sa[mple]= <i>n</i>	sa=0			0 to 4000
<b>Set serial duplex mode:</b>	<b>du[plex]=f[ull]/h[alf]</b>				FULL or HALF
Set serial duplex mode to full	du[plex]=f[ull]	du=f			
Set serial duplex mode to half	du[plex]=h[alf]	du=h			
<b>Set serial linefeed mode:</b>	<b>lf[eed]=on/off[f]</b>				ON or OFF
Set serial linefeed mode to on	lf[eed]=on	lf=on			
Set serial linefeed mode to off	lf[eed]=off[f]	lf=of			
<b>Calibration Menu</b>					
Read low set-point limit value	*tl[ow]	*tl	tl: 999	tl: -80	
Set low set-point limit to <i>n</i>	*tl[ow]= <i>n</i>	*tl=-80			-999.9 to 999.9
Read high set-point limit value	*th[igh]	*th	th: 999	th: 205	
Set high set-point limit to <i>n</i>	*th[igh]= <i>n</i>	*th=205			-999.9 to 999.9
<b>Miscellaneous (not on menus)</b>					
Read firmware version number	*ver[sion]	*ver	ver.9999,9.99	ver.2100,3.56	
Read structure of all commands	h[elp]	h	list of commands		
Read Heater	f1	f1	f1:9	f1:1	
<b>Set Heater</b>	<b>f1=1/0</b>				<b>0 or 1</b>
Set heater to low	f1= <i>n</i>	f1=0			
Set heater to high	f1= <i>n</i>	f1=1			
Read Refrigeration	f2	f2	f2:9	f2:0	
<b>Set Refrigeration</b>	<b>f2=1/0</b>				<b>0 or 1</b>
Set Refrigeration to on	f2= <i>n</i>	f2=1			
Set Refrigeration to off	f2= <i>n</i>	f2=0			
Read Expansion Valve 1	f3	f3	f3:9	f3:1	
<b>Set Expansion Valve 1</b>	<b>f3=1/0</b>				<b>0 or 1</b>
Set Expansion Valve 1 to on	f3= <i>n</i>	f3=1			
Set Expansion Valve 1 to off	f3= <i>n</i>	f3=0			
Read Cooling Power	f4	f4	f4:9	f4:1	
<b>Set Back Pressure</b>	<b>f4=1/0</b>				<b>0 or 1</b>
Set back pressure on	f4= <i>n</i>	f4=1			
Set back pressure off	f4= <i>n</i>	f4=0			
Legend:	[] Optional Command data {} Returns either information <i>n</i> Numeric data supplied by user 9 Numeric data returned to user <i>x</i> Character data returned to user				
Note:	When DUPLEX is set to FULL and a command is sent to READ, the command is returned followed by a carriage return and linefeed. Then the value is returned as indicated in the RETURNED column.				

may be used. Commands may be abbreviated to the minimum number of letters which determines a unique command. A command may be used to either set a parameter or display a parameter depending on whether or not a value is sent with the command following a “=” character. For example “s”<CR> will return the current set-point and “s=50.00”<CR> will set the set-point to 50.00 degrees.

In the following list of commands, characters or data within brackets, “[” and “]”, are optional for the command. A slash, “/”, denotes alternate characters or data. Numeric data, denoted by “n”, may be entered in decimal or exponential notation. Characters are shown in lower case although upper case may be used. Spaces may be added within command strings and will simply be ignored. Backspace (BS, ASCII 8) may be used to erase the previous character. A terminating CR is implied with all commands.

## **10.4 Power Control Functions**

The digital interface is capable of controlling the heating and cooling functions so that the bath can be remotely operated at any temperature within the range of the bath. To allow the interface to control the heating and the cooling, the front panel controls are disabled by 1) switching the heater switch to LOW, and 2) switching the refrigeration switch to OFF. Otherwise, the interface would not be able to switch these functions off. The 7012 bath has four control functions with the digital interface. These are heater power high/low, cooling on/off, expansion valve on/off, and back pressure valve on/off.

### **10.4.1 Heater Control**

To control the heater with the digital interface the front panel heater switch must be set to LOW (500 W). The heater function is controlled with the “F1” command. Setting the “F1” parameter to 0 sets the heater to LOW (500 W) and setting it to 1 sets the heater to HIGH (1000 W). Sending “F1” with no value causes the controller to return a value showing what the heater setting is. When the heater setting is changed a pop is heard as the heater relay opens or closes.

### **10.4.2 Cooling Control**

To control the refrigeration power with the digital interface the front panel refrigeration switch must be off. The refrigeration power function is controlled with the “F2” command. Setting the “F2” value to 0 turns the refrigeration off and setting it to 1 turns it on. “F2” alone returns 0 or 1 showing the state of the refrigeration power control.

The “F3” command controls the “high” and “low” cooling temperature range or expansion valves. As discussed in Section 7.2 this valve adjusts the cooling temperature which sets the cooling capacity. Setting “F3” to 1 opens the valve (on or high) and 0 closes the valve (off or low). A command with no value returns the current value. With the valve closed the cooling temperature is set with the cooling temperature knob labeled “LOW”. This should be adjusted for approximately 9–14 psi if the bath is to be used as low as –10°C. The knob la-

beled “HIGH” controls the cooling temperature when the expansion valve is open or on. This should be adjusted for approximately 45–50 psi. These values are typical but may be adjusted as required for specific applications. The low range must be set to a lower pressure (temperature) than the high range valve.

The “F4” command controls the back pressure valve. When the valve is open the cooling capacity is significantly reduced. This valve should normally be left off/closed throughout the operating range of the bath. Table 5 summarizes the control functions for heating and cooling. Table 6 shows the recommended control settings for each operating temperature range. The ranges may need to be adjusted depending on the bath application.

**Table 5** *Serial Power Control Functions*

Function	Command	0	1
Heater	F1	low	high
Refrigeration	F2	off	on
Expansion valve	F3	open	closed
Back pressure	F4	open	closed

**Table 6** *Temperature Range Control Functions*

Range	Heater	Refr.	Exp.
–10 to 15°C	low	on	open
15 to 40°C	low	on	closed
40 to 110°C	low/high	off	open

## 11 Calibration Procedure



*Note: This procedure is to be considered a general guideline. Each laboratory should write their own procedure based on their equipment and their quality program. Each procedure should be accompanied by an uncertainty analysis also based on the laboratory's equipment and environment.*

In some instances the user may want to calibrate the bath to improve the temperature set-point accuracy. Calibration is done by adjusting the controller probe calibration constants DO and DG so that the temperature of the bath as measured with a standard thermometer agrees more closely with the bath set-point. The thermometer used must be able to measure the bath fluid temperature with higher accuracy than the desired accuracy of the bath. By using a good thermometer and carefully following the procedure the bath can be calibrated to an accuracy of better than  $0.1^{\circ}\text{C}$  over a range of 50 degrees.

### 11.1 Calibration Points

In calibrating the bath DO and DG are adjusted to minimize the set-point error at each of two different bath temperatures. Any two reasonably separated bath temperatures may be used for the calibration however best results are obtained when using bath temperatures which are just within the most useful operating range of the bath. The farther apart the calibration temperatures the larger will be the calibrated temperature range but the calibration error will also be greater over the range. If for instance  $20^{\circ}\text{C}$  and  $80^{\circ}\text{C}$  are chosen as the calibration temperatures, the bath may achieve an accuracy of say  $\pm 0.2^{\circ}\text{C}$  over the range 20 to  $80^{\circ}\text{C}$ . Choosing  $30^{\circ}\text{C}$  and  $70^{\circ}\text{C}$  may allow the bath to have a better accuracy of maybe  $\pm 0.05^{\circ}\text{C}$  over the range 30 to  $70^{\circ}\text{C}$  but outside that range the accuracy may be only  $\pm 0.5^{\circ}\text{C}$ .

### 11.2 Measuring the Set-point Error

The first step in the calibration procedure is to measure the temperature errors (including sign) at the two calibration temperatures. First set the bath to the lower set-point which we will call  $t_L$ . Wait for the bath to reach the set-point and allow 15 minutes to stabilize at that temperature. Check the bath stability with the thermometer. When both the bath and the thermometer have stabilized measure the bath temperature with the thermometer and compute the temperature error  $\text{err}_L$  which is the actual bath temperature minus the set-point temperature. If for example the bath is set for a lower set-point of  $t_L=20^{\circ}\text{C}$  and the bath reaches a measured temperature of  $19.7^{\circ}\text{C}$  then the error is  $-0.3^{\circ}\text{C}$ .

Next, set the bath for the upper set-point  $t_H$  and after stabilizing measure the bath temperature and compute the error  $\text{err}_H$ . For our example we will suppose

the bath was set for 80°C and the thermometer measured 80.1°C giving an error of +0.1°C.

## 11.3 Computing D0 and DG

Before computing the new values for D0 and DG the current values must be known. The values may be found by either accessing the probe calibration menu from the controller panel or by inquiring through the digital interface. The user should keep a record of these values in case they may need to be re-stored in the future. The new values DO' and DG' are computed by entering the old values for DO and DG, the calibration temperature set-points  $t_L$  and  $t_H$ , and the temperature errors  $err_L$  and  $err_H$  into the following equations,

$$D0' = \frac{err_L (t_H - D0) - err_H (t_L - D0)}{t_H - t_L} + D0$$

$$DG' = \left[ \frac{err_H - err_L}{t_H - t_L} + 1 \right] DG$$

If for example D0 and DG were previously set for -25.229 and 186.9740 respectively and the data for  $t_L$ ,  $t_H$ ,  $err_L$ , and  $err_H$  were as given above then the new values D0' and DG' would be computed as -25.831 and 188.220 respectively. Program the new values D0 and DG into the controller. The new constants will be used the next time the bath temperature is set. Check the calibration by setting the temperature to  $t_L$  and  $t_H$  and measuring the errors again. If desired the calibration procedure may be repeated again to further improve the accuracy.

## 11.4 Calibration Example

The bath is to be used between 25 and 75°C and it is desired to calibrate the bath as accurately as possible for operation within this range. The current values for D0 and DG are -25.229 and 186.974 respectively. The calibration points are chosen to be 25.00 and 75.00°C. The measured bath temperatures are 24.869 and 74.901°C respectively. Refer to Figure 10 for applying the equations to the example data and computing the new probe constants.

$$D_0 = -25.229$$

$$DG = 186.974$$

$$t_L = 25.00^\circ\text{C}$$

$$\text{measured } t = 24.869^\circ\text{C}$$

$$t_H = 75.00^\circ\text{C}$$

$$\text{measured } t = 74.901^\circ\text{C}$$

Compute errors,

$$\text{err}_L = 24.869 - 25.00^\circ\text{C} = -0.131^\circ\text{C}$$

$$\text{err}_H = 74.901 - 75.00^\circ\text{C} = -0.099^\circ\text{C}$$

Compute  $D_0$ ,

$$D_0' = \frac{(-0.131)(75.0 - (-25.229)) - (-0.099)(25.0 - (-25.229))}{75.0 - 25.0} + (-25.229) = -25.392$$

Compute  $DG$ ,

$$DG' = \left[ \frac{(-0.099) - (-0.131)}{75.0 - 25.0} + 1 \right] 186.974 = 187.094$$

**Figure 10** Sample calibration computations

## 12 Maintenance

The calibration instrument has been designed with the utmost care. Ease of operation and simplicity of maintenance have been a central theme in the product development. Therefore, with proper care the instrument should require very little maintenance. Avoid operating the instrument in dirty or dusty environments.

- A battery is used to maintain operating parameters in the unit. All operating parameters, including calibration parameters should be checked on a regular basis to insure accuracy and proper operation of the instrument. See the troubleshooting section for the procedure on checking the status of the battery.
- The bath should be cleaned regularly to prevent a buildup of oil or dust. Use a paint safe cleaning agent on all painted surfaces. Solvents such as Trichloroethylene or Acetone may dull or dissolve the paint. The stainless steel surfaces may be cleaned with solvents as necessary to remove oils.
- The stirring motor should be clean to allow proper cooling. Normally only the outside surfaces require any attention. If the inside of the motor has become heavily loaded with oily dust, blow it out with compressed air. Follow normal safety procedures when using pressurized gasses.
- Periodically check the fluid level in the bath to ensure that the level has not dropped. A drop in the fluid level affects the stability of the bath. Changes in fluid level are dependent upon several factors specific to the environment in which the equipment is used. A schedule cannot be outlined to meet each environmental setting. Therefore, the first year the bath should be checked weekly with notes kept as to changes in bath fluid. After the first year, the user can set up a maintenance schedule based on the data specific to the application.
- Heat transfer medium lifetime is dependent upon the type of medium and the environment. The fluid should be checked at least every month for the first year and regularly thereafter. This fluid check provides a baseline for knowledge of bath operation with clean, usable fluid. Once some fluids have become compromised, the break down can occur rapidly. Particular attention should be paid to the viscosity of the fluid. A significant change in the viscosity can indicate that the fluid is contaminated, being used outside of its temperature limits, contains ice particles, or is close to a chemical breakdown. Once data has been gathered, a specific maintenance schedule can be outlined for the instrument. Refer to the General Operation section (Section 8) for more information about the different types of fluids used in calibration baths.
- If a hazardous material is spilt on or inside the equipment, the user is responsible for taking the appropriate decontamination steps as outlined by the national safety council with respect to the material. MSDS sheets applicable to all fluids used in the baths should be kept in close proximity to the instrument.

- If the mains supply cord becomes damaged, replace it with a cord with the appropriate gauge wire for the current of the bath. If there are any questions, contact an Authorized Service Center for more information.
- Before using any cleaning or decontamination method except those recommended by Hart, users should check with an Authorized Service Center to be sure that the proposed method will not damage the equipment.
- If the instrument is used in a manner not in accordance with the equipment design, the operation of the bath may be impaired or safety hazards may arise.



**WARNING:** *When checking the over-temperature cutout, be sure that the temperature limits of the bath fluid are not exceeded. Exceeding the temperature limits of the bath fluid could cause harm to the operator, lab, and instrument.*

- The over-temperature cutout should be checked every 6 months to see that it is working properly. In order to check the user selected cutout, follow the controller directions (Section 9.8) for setting the cutout. Both the manual and the auto reset option of the cutout should be checked. Set the bath temperature higher than the cutout. Check to see if the display flashes cutout and the temperature is decreasing.
- The constant temperature bath depends upon the certain qualities of the fluid medium in order to maintain a uniform and stable temperature environment. Some oils change their characteristics or become dirty after a period of use. Always remove any foreign materials from the bath.
- Silicone oils as well as others may evaporate off their lighter components over a period of time leaving the very viscous components remaining. In addition, some decomposition occurs which may impair the temperature stability of the bath. When this happens, the fluid is generally very dark to black and viscous. Vegetable oils polymerize (turn plastic like) after they have been used for a time at high temperatures making them very difficult to remove. When the oil has become unusable it should be changed. The instructions for removing the oil is as follows.

## 12.1 Draining the Bath

The drain is located on the back of the bath. See [Figure 4](#) on page 24. Locate the drain plug on the end of the drain tube. This drain plug is to be fluid tight until the time of draining. The following information is helpful when draining the bath. Always use a container capable of holding the entire load of fluid. Using an adequate size (about 8 gallons or 1 cubic foot), heat proof fluid container is extremely important. Use safety equipment as appropriate.

1. Water and low viscosity fluids - Drain at room temperature. Normal care must be taken for fluids that may have corrosive or damaging effects on the surrounding facility or equipment.



2. High viscosity oils - The fluid should be sufficiently low in viscosity to drain efficiently. Some oils such as 710 silicone oil may need to be heated to 80°C to be fluid enough to drain well. The viscosity affects how rapidly it drains as well as how well it flows off of the walls. Heat proof containers and appropriate safety equipment such as face shields, gloves and body covering are recommended.



**WARNING:** *Extreme danger of BURNS and FIRE. Use safety equipment, use proper equipment and have fire safety equipment standing by.*

## 13 Troubleshooting

This section contains information on troubleshooting and CE Comments. This information pertains to a number of bath models and certain specifics may not pertain to your model.

### 13.1 Troubleshooting

In the event that the instrument appears to function abnormally, this section may help to find and solve the problem. Several possible problem conditions are described along with likely causes and solutions. If a problem arises, please read this section carefully and attempt to understand and solve the problem. If the probe seems faulty or the problem cannot otherwise be solved, contact an Authorized Service Center (see Section 1.3, on page 5) for assistance. Be sure to have the instrument model number, serial number, voltage, and problem description available.

Problem	Causes and Solutions
The heater indicator LED stays red but the temperature does not increase	<p>The display does not show “Cut-out” nor displays an incorrect bath temperature, and the controller otherwise appears to operate normally. The problem may be insufficient heating, no heating at all, or too much cooling.</p> <ul style="list-style-type: none"> <li>• The heater power setting being too low, especially at higher operating</li> <li>• One or more burned out heaters or blown heater fuses may also cause this problem. If the heaters seem to be burned out, contact an Authorized Service Center (see Section 1.3, on page 5) for assistance.</li> </ul>
The controller display flashes “Cut-out” and the heater does not operate	<p>The display flashes “Cut-out” alternately with the process temperature.</p> <ul style="list-style-type: none"> <li>• If the process temperature displayed seems grossly in error, consult the following problem: <i>The display flashes “Cut-out” and an incorrect process temperature</i>.</li> <li>• Normally, the cutout disconnects power to the heater when the bath temperature exceeds the cutout set-point causing the temperature to drop back down to a safe value. If the cutout mode is set to “AUTO”, the heater switches back on when the temperature drops. If the mode is set to “RESET”, the heater only comes on again when the temperature is reduced and the cutout is manually reset by the operator, see Section 9.8, Cutout. Check that the cutout set-point is adjusted to 10 or 20°C above the maximum bath operating temperature and that the cutout mode is set as desired.</li> <li>• If the cutout activates when the bath temperature is well below the cutout set-point or the cutout does not reset when the bath temperature drops and it is manually reset, then the cutout circuitry or the cutout thermocouple sensor may be faulty or disconnected. Contact an Authorized Service Center (see Section 1.3, on page 5) for assistance.</li> </ul>

Problem	Causes and Solutions
The display flashes “cutout” and an incorrect process temperature	<p>The problem may be that the controller's voltmeter circuit is not functioning properly.</p> <ul style="list-style-type: none"> <li>• A problem could exist with the memory back-up battery. If the battery voltage is insufficient to maintain the memory, data may become scrambled causing problems. A nearby large static discharge may also affect data in memory. Verify that the parameters on the Report of Test are accurate. Cycle the power off, disconnect the bath from AC, and then restart the bath.</li> <li>• The controller may need to be reset. Perform the following <b>Factory Reset Sequence</b>. Hold the SET and EXIT buttons down at the same time while powering up the instrument. The instrument display shows 'F.01E-', the model number, and the firmware version. Each of the controller parameters and calibration constants must be reprogrammed. The values can be found on the Report of Test that was shipped with the instrument.</li> <li>• If initializing the memory does not remedy the problem, there may be a failed electronic component. Contact an Authorized Service Center (see Section 1.3, on page 5) for assistance.</li> </ul>
The displayed process temperature is in error and the controller remains in the cooling or the heating state at any set-point value	<p>Possible causes may be either a faulty control probe or erroneous data in memory.</p> <ul style="list-style-type: none"> <li>• The probe may be disconnected, burned out, or shorted.</li> <li>• Check that the probe is connected properly. The probe may be checked with an ohmmeter to see if it is open or shorted. The probe is a thermistor. The resistance should read approximately 3 kohms between pins 3 and 4, 12 kohms between pins 1 and 4, and 9-11 kohms between pins 1 and 3 at room temperature (25°C). If the probe appears to be defective, contact an Authorized Service Center (see Section 1.3, on page 5) for assistance.</li> <li>• If the problem is not the probe, erroneous data in memory may be the cause. Re-initialize the memory as discussed in the problem <i>'The display flashes “cutout” and an incorrect process temperature'</i>. If the problem remains, the cause may be a defective electronic component, contact an Authorized Service Center (see Section 1.3, on page 5) for assistance.</li> </ul>

Problem	Causes and Solutions
<p>The controller controls or attempts to control at an inaccurate temperature</p>	<p>The controller operates normally except when controlling at a specified set-point. At this set-point, the temperature displayed does not agree with the temperature measured by the user's reference thermometer to within the specified accuracy. This problem may be caused by an actual difference in temperature between the points where the control probe and thermometer probe measure temperature, by erroneous bath calibration parameters, or by a damaged control probe.</p> <ul style="list-style-type: none"> <li>• Check that the bath has an adequate amount of fluid in the tank and that the stirrer is operating properly.</li> <li>• Check that the thermometer probe and control probe are both fully inserted into the bath to minimize temperature gradient errors.</li> <li>• Check that the calibration parameters are all correct according to the Report of Test. If not, re-program the constants. The memory backup battery may be weak causing errors in data as described in the problem: <i>'The display flashes "cutout" and an incorrect process temperature'</i>.</li> <li>• Check that the control probe has not been struck, bent, or damaged. If the cause of the problem remains unknown, contact an Authorized Service Center (see Section 1.3, on page 5) for assistance.</li> </ul>
<p>The controller shows that the output power is steady but the process temperature is unstable</p>	<p>Possible causes are an improper proportional band setting or the fluid being used.</p> <ul style="list-style-type: none"> <li>• If the bath temperature does not achieve the expected degree of stability when measured using a thermometer, try adjusting the proportional band to a narrower width as discussed in Section 9.7, Proportional Band.</li> <li>• Check to ensure the fluid has not deteriorated or is not too thick.</li> </ul>
<p>The controller alternately heats for a while then cools</p>	<p>The bath is not stable and the duty cycle is not constant.</p> <ul style="list-style-type: none"> <li>• The proportional band being too narrow typically causes this oscillation. Increase the width of the proportional band until the temperature stabilizes as discussed in Section 9.7, Proportional Band.</li> </ul>
<p>The controller erratically heats then cools, control is unstable</p>	<p>If both the bath temperature and output power do not vary periodically but in a very erratic manner, the problem may be excess noise in the system. Noise due to the control sensor should be less than 0.001°C. However, if the probe has been damaged or has developed an intermittent short, erratic behavior may exist. The probe is located inside the stirrer motor cover.</p> <ul style="list-style-type: none"> <li>• Check for a damaged probe or poor connection between the probe and bath.</li> <li>• Intermittent shorts in the heater or controller electronic circuitry may also be a possible cause. Contact an Authorized Service Center (see Section 1.3, on page 5) for assistance.</li> </ul>

Problem	Causes and Solutions
The bath does not achieve low temperatures	Too much heating or not enough cooling can cause this problem. <ul style="list-style-type: none"><li>• Check that the control indicator glows green showing that the controller is attempting to cool. The heaters may be disabled as a test by temporarily removing the heater fuses.</li></ul>
The controller does not maintain controller parameters or parameters are reset each time the power to the unit is removed	<p><b>Note:</b> Before performing the memory check, you need to record the controller calibration parameters (found in the CAL menu of the instrument) and any user-adjusted parameters that you have changed (such as the programmable set points and proportional band).</p> <p><b>Memory Check</b></p> <p>Doing a memory check is the easiest way to verify the ability of the battery to maintain controller parameters.</p> <ol style="list-style-type: none"><li>1. Power off the instrument.</li><li>2. Disconnect the instrument from AC power for 10 seconds.</li><li>3. Reconnect the AC power and power on the instrument.</li><li>4. If the display shows InIT and/or the cycle count shows a low number such as 0002, the battery is spent and should be replaced. Contact an Authorized Service Center for assistance.</li><li>5. After replacing the battery, you must reprogram the calibration and user-adjustable parameters into the controller.</li></ol>

## 13.2 Comments

### 13.2.1 EMC Directive

Hart Scientifics' equipment has been tested to meet the European Electromagnetic Compatibility Directive (EMC Directive, 89/336/EEC). The Declaration of Conformity for your instrument lists the specific standards to which the unit was tested.

### 13.2.2 Low Voltage Directive (Safety)

In order to comply with the European Low Voltage Directive (73/23/EEC), Hart Scientific equipment has been designed to meet the IEC 1010-1 (EN 61010-1) and the IEC 1010-2-010 (EN 61010-2-010) standards.